



WHITE PINES
BRACEBRIDGE
PHASE 11

myDESIGNSTUDIO



Table of Contents

Included Kitchen & Bath Cabinets	3
Cabinet Upgrades	7
Cabinet Hardware	17
Solid Surface Countertops	21
Floor Tiles	31
Wall Tiles	51
Backsplash	59
Shower Mosaics	70
Hardwood Flooring	81
Luxury Vinyl and Laminate Flooring	90
Carpet	94
Door and Hardware Options	99
Trim and Paint Option	113
Stair Upgrades	118
Fireplace Options	124

2/24/2023





Cabinetry Packages and Options



Kitchen Cabinetry Package Options

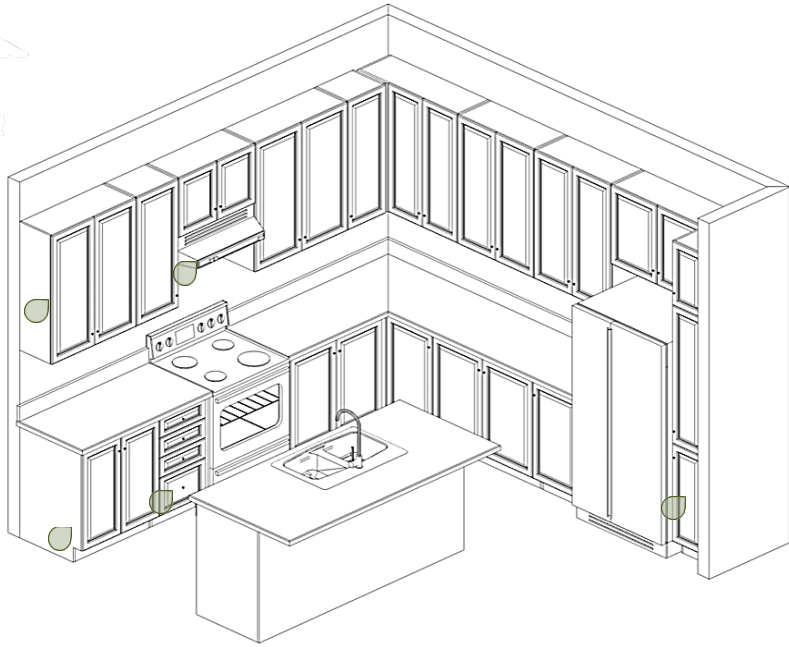

STANDARD KITCHEN: ●

as per Schedule A

- Base and Upper cabinets
- Pantry Cabinet
- one Bank of drawers (4 drawers)
- Standard appliances and openings

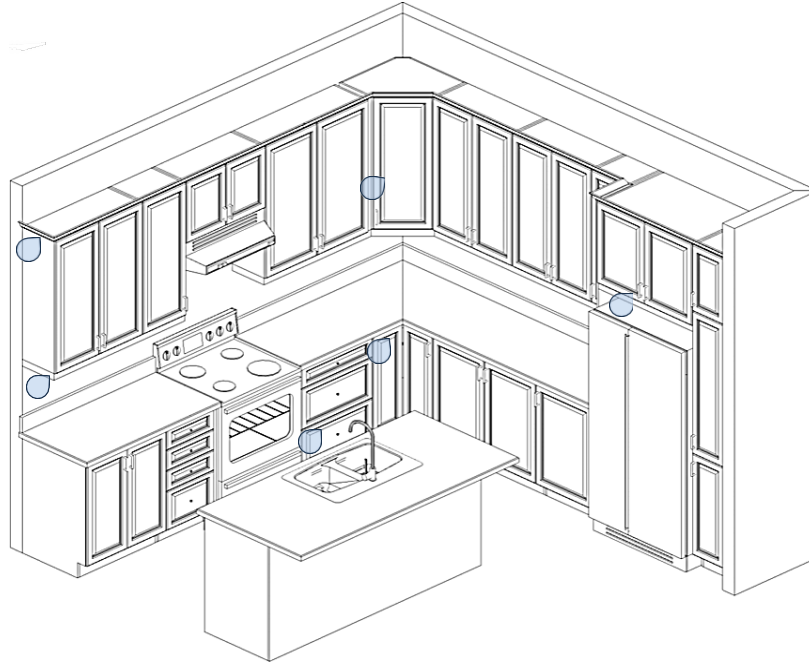

EXECUTIVE / LUXURY KITCHEN PACKAGE: ●

in addition to Standard Kitchen features

- + Pot and pan drawers
- + Deep Upper cabinets above Refrigerator (with Gable)
- + Light valance
- * Crown Molding
- * Base Pie-cut corner cabinet
- * Angled Upper corner cabinet

*not included in LUXURY PACKAGE offered to compact attached homes

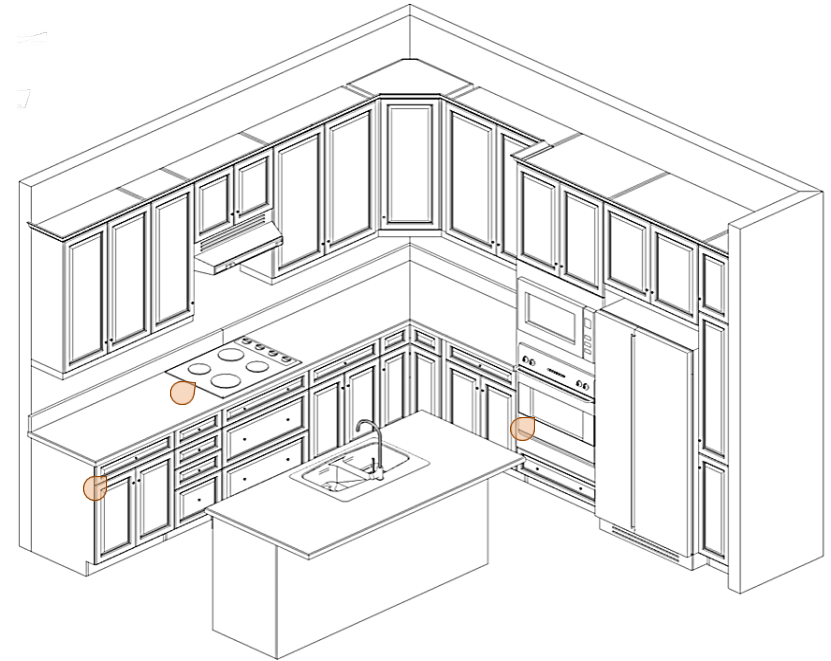

GRANDE KITCHEN PACKAGE: ●

in addition to Executive / Luxury Kitchen Package features

- + Top drawer construction
- + Cooktop cutout
- + Built-in Oven / Microwave Cutout

Cabinet options listed are exclusive to each package and not available a la carte.

Images used for representational purposes only. Kitchen configuration and Kitchen Cabinetry Packages available to your specific home may vary depending on Model, Kitchen size, Supplier and Community.

Additional Cabinetry Options

a la carte Color, Finish & Door Options

Deleted upper cabinet
for Chimney hood fan

Cabinet Doors available in
solid, clear or frosted glass
and soft-close hardware

Additional Pot & Pan drawers
**Executive, Luxury & Grande Package only*

Decorative faux door
cladding

Extended Island Gable
(in lieu of overhang)

Furniture Toe-kick



Open shelving

Matching cabinet interiors

Flip-up cabinet doors with
soft-close hardware

Two-tone Kitchen Cabinetry
(contrasting Island color)

Additional Cabinetry Options

Appliance Cabinetry Options

Built-in Appliance Options:

**full appliance specs required during Design Appointment*



Chimney Hood Fan in place of upper cabinet

Cooktop cut-out

Built-in small appliance in Pantry Cabinet
(for coffee machine and other appliances); also available for Base cabinets

Deep Upper Cabinets above Refrigerator
(with Gable)

Built-in Oven and Microwave cut-out

**Bumpout available for cooktop or sink (not shown here)*

Bar refrigerator accommodation

Appliance Shelf Options:

Small Appliance shelf in Upper Cabinet

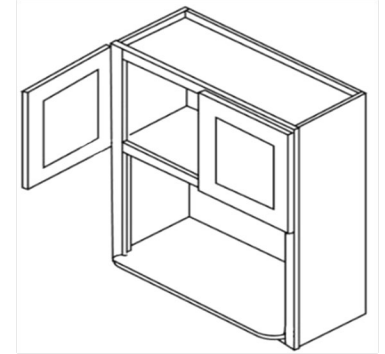

Small Appliance shelf in Base Cabinet

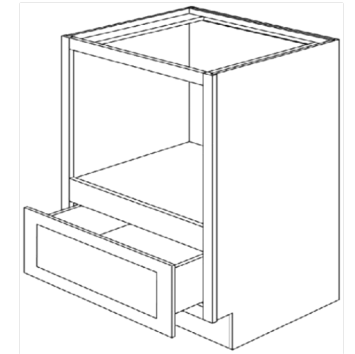

*Decorative Option:

Cabinet bump-out for cooktop or sink



Additional Cabinetry Options

Fittings and Organizer Options

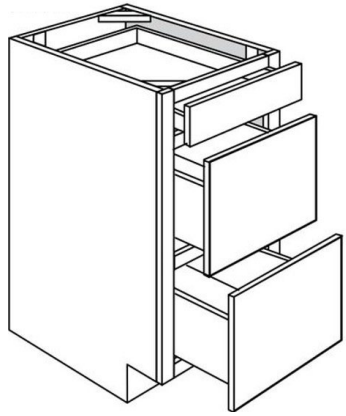

Pot & Pan drawers
(three drawers)

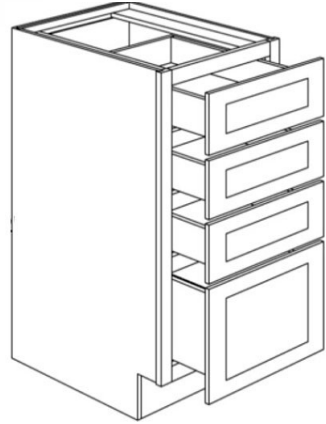

Bank of Drawers
(four drawers)

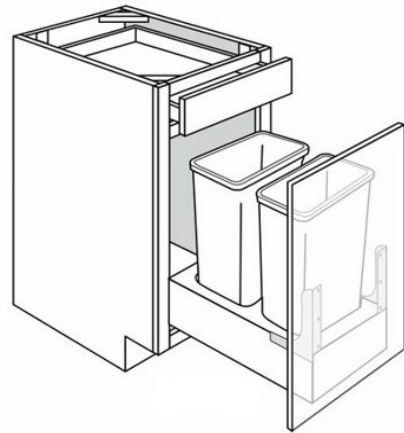

Recycling Centre

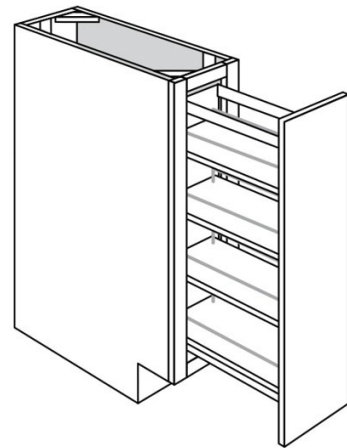

Pull-out Spice Rack

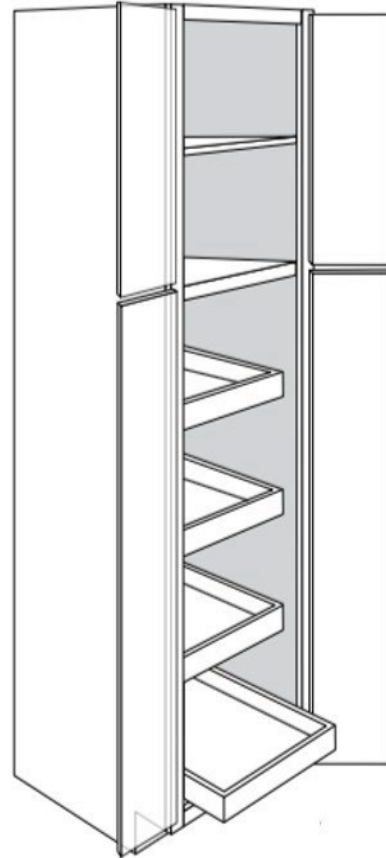

Roll-out Drawers (Pantry)



Tray Dividers (Upper cabinet)
**divider may vary according to supplier*

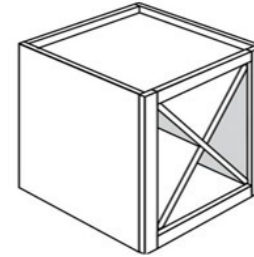

Wine Rack

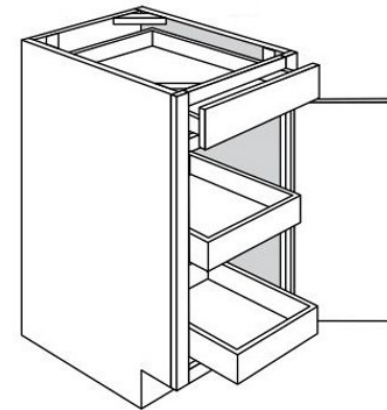

Roll-out Drawers (Base Cabinet)

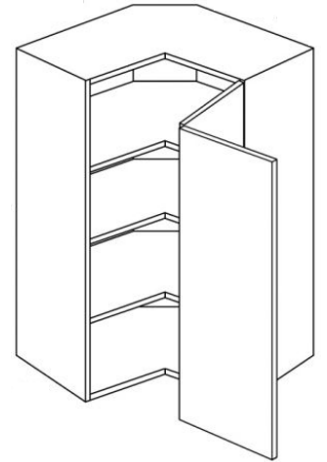

Pie-cut Upper Cabinet
(in lieu of angled upper)

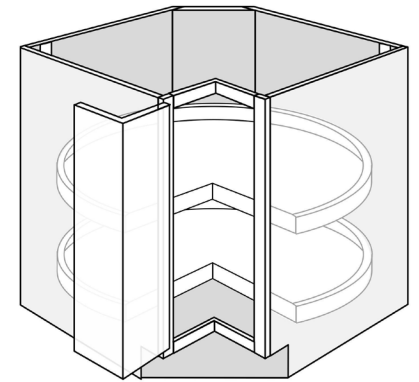

Lazy Susan in Corner Pie-cut
Base Cabinet

Additional Cabinetry Options

Upper cabinets, Hood Fan cabinet and Kitchen Island Options



UPPER CABINETS and BULKHEAD	Stacked Upper Cabinets with solid doors	Stacked Upper Cabinets with clear glass doors	Bulkhead deleted	Bulkhead retained
HOOD FAN CABINET	“Signature”	“Décor”	“Contemporary”	“Premiere”
KITCHEN ISLAND	Island end panels clad with decorative faux door panels and furniture toe kick (overhang retained)	Extended Island gables (in lieu of overhang) clad with decorative faux door panels and furniture toe kick	Waterfall Gable (Quartz)	Large 6x6 post with end panels clad with decorative faux door panels and furniture toe kick

Bathroom Cabinetry Options



"Comfort Height" Vanity (36")



Decorative faux door
end panel and toe kick

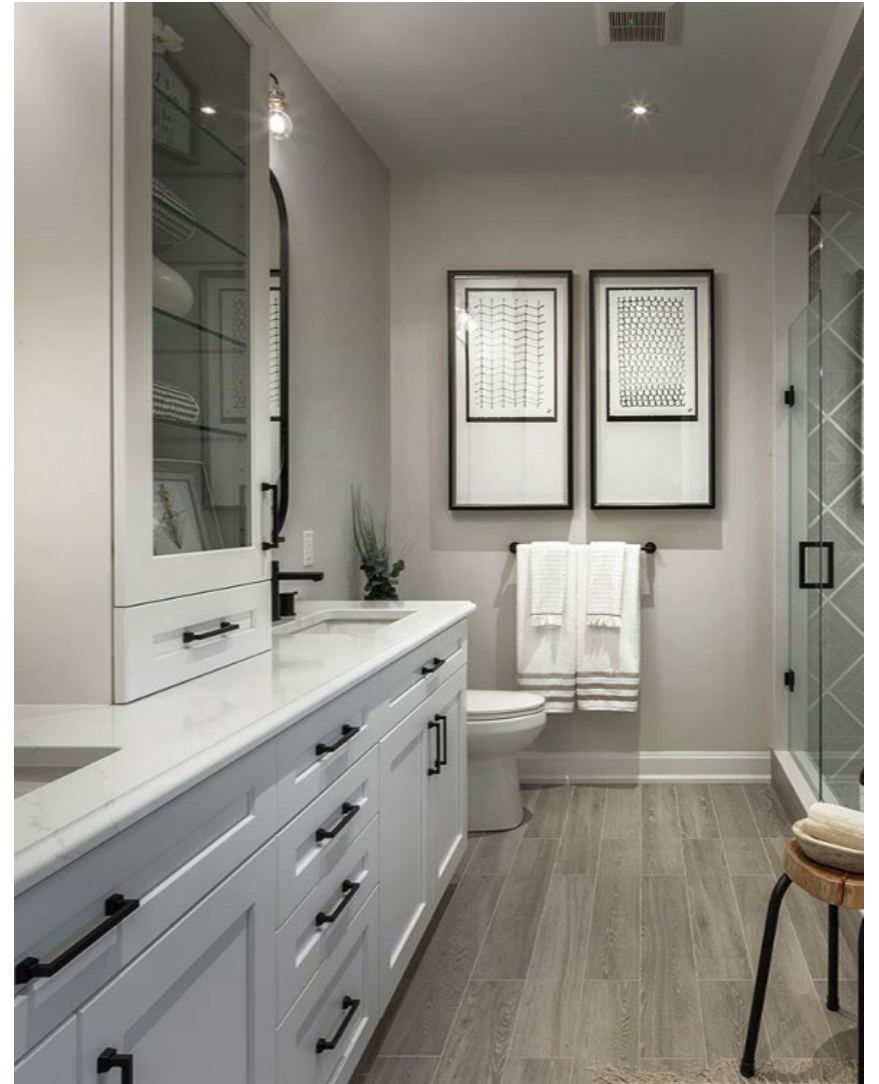

Vanity Cabinet with Hutch

Laundry & Mud Room Cabinetry Options



Additional cabinets in
Laundry room



Mud Room Lockers
(only available as ACO at Sales)



Kitchen & Bath Cabinet Options

Line 2 - Included Maple

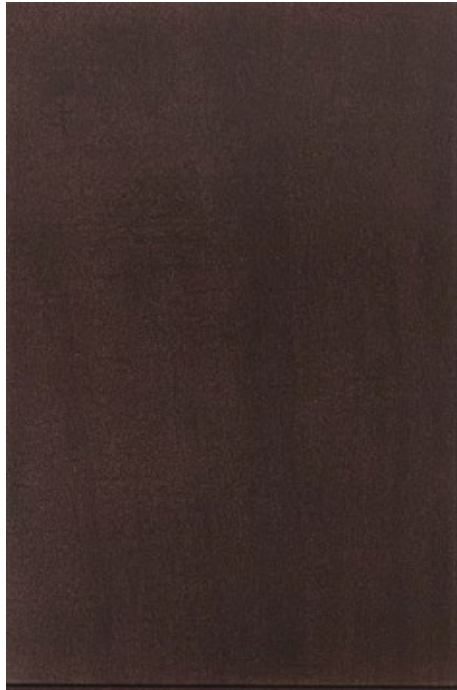

POLO
Maple

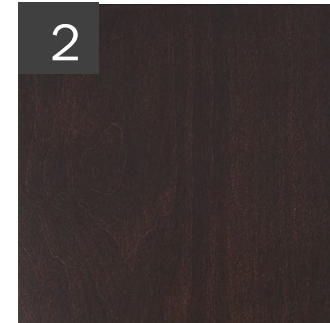
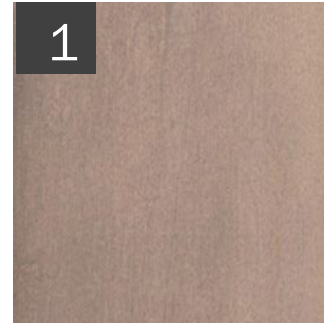

* AVAILABLE COLORS:

- 1. TRUFFLE
- 2. WENGE

Line 2 – Included Melamine

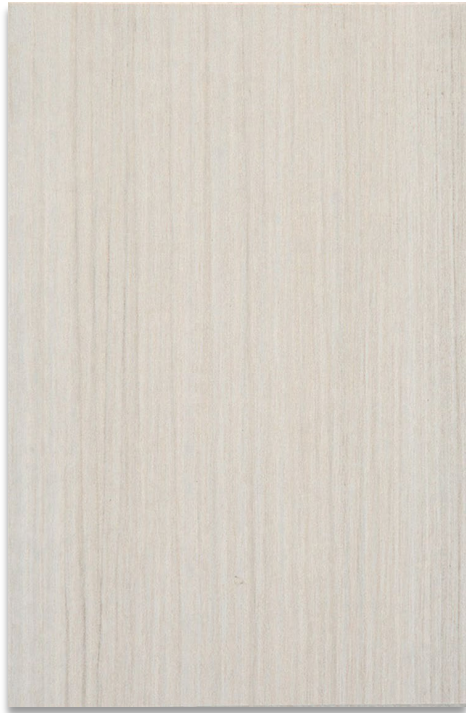

C O M O
M e l a m i n e

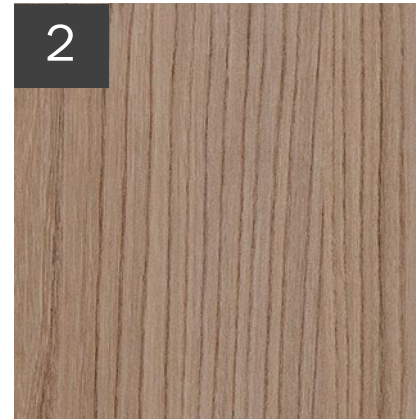
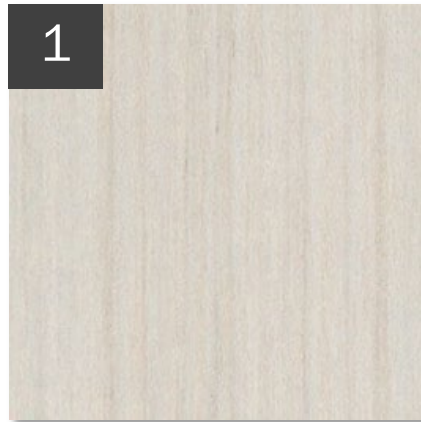

- * AVAILABLE COLORS:
1. LARICE BIANCO
 2. OLMO AMBIANCE

Line 2 – Included Thermofoil



MISSION
Thermofoil

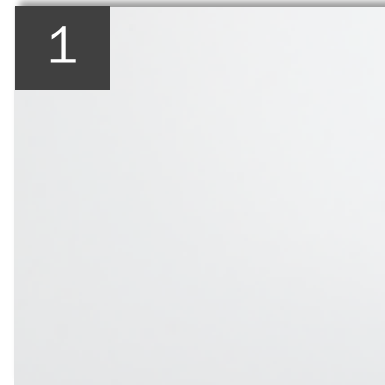

1. WHITE

ONLY AVAILABLE FOR BATHROOM & LAUNDRY ROOM CABINETS

Line 3 - Maple Upgrade



S O H O
M a p l e



V E N E Z I A
M a p l e



- * AVAILABLE COLORS:
1. ANISE

Line 3 - Painted Upgrade

S O H O



V E N E Z I A

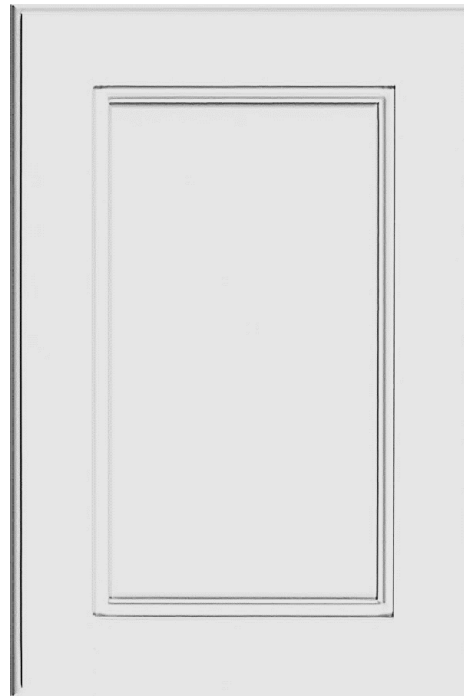

O D Y S S E Y

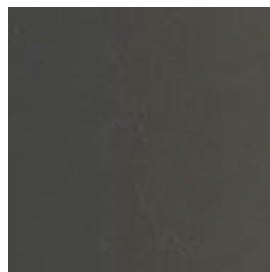

ANTHRACITE



DOVE GREY



REVERE PEWTER

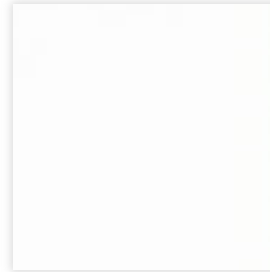

WHITE

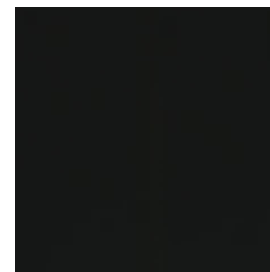

EBONY

Line 3 – P.E.T. Upgrade



MONDOLFI
P.E.T.

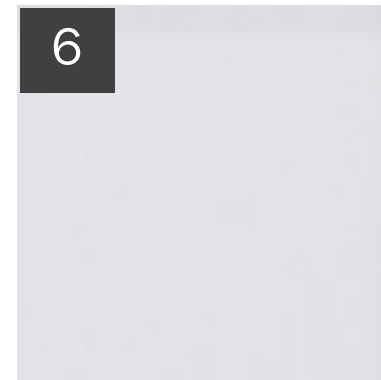
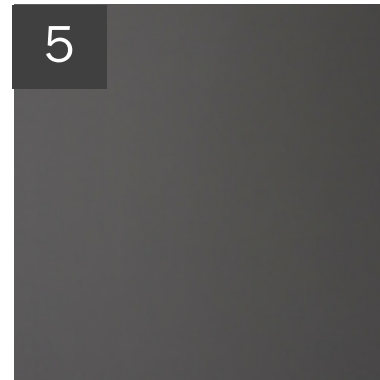
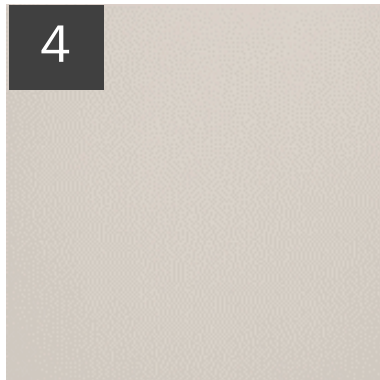
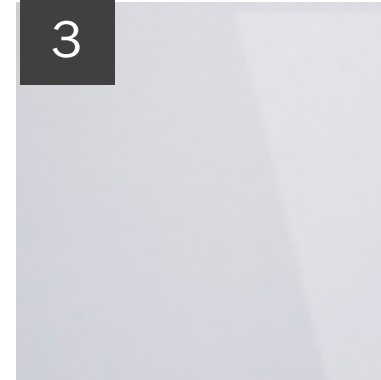
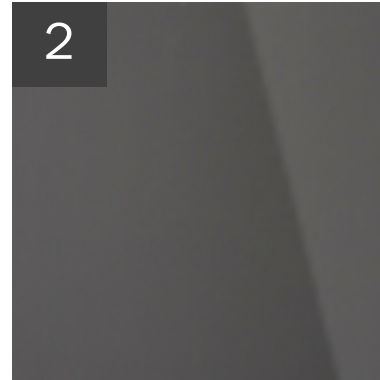

* AVAILABLE COLORS:

1. NATURAL GREY HG
2. GRIS GU HG
3. BLANCO ARTICO HG
4. NATURAL GREY SATIN
5. GRIS GU SATIN
6. BLANCO ARTICO SATIN

Line 4 – Maple Upgrade

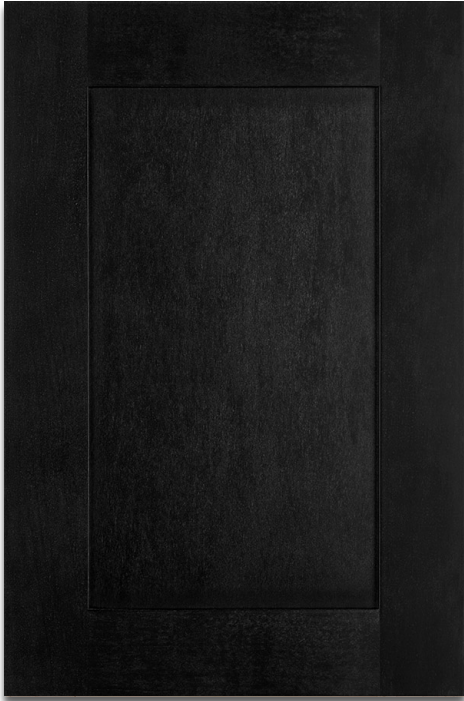

S O H O
M a p l e



V E N E Z I A
M a p l e

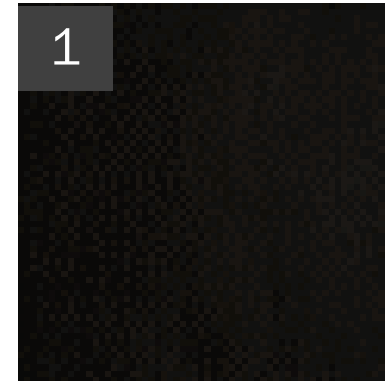

PEPPER

Line 4 – Maple Upgrade



NEWPORT

* AVAILABLE
COLORS:



AZTEC

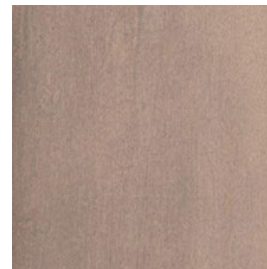

TRUFFLE

Line 4 - Painted Upgrade



E U R O P A



N E W P O R T



A U R O R A

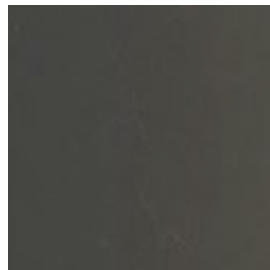

ANTHRACITE



DOVE GREY

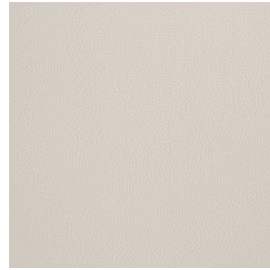

REVERE PEWTER

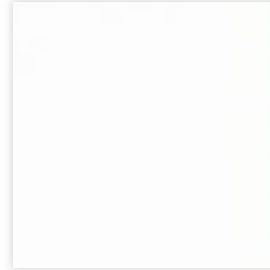

WHITE



EBONY

Line 4 - Painted Upgrade

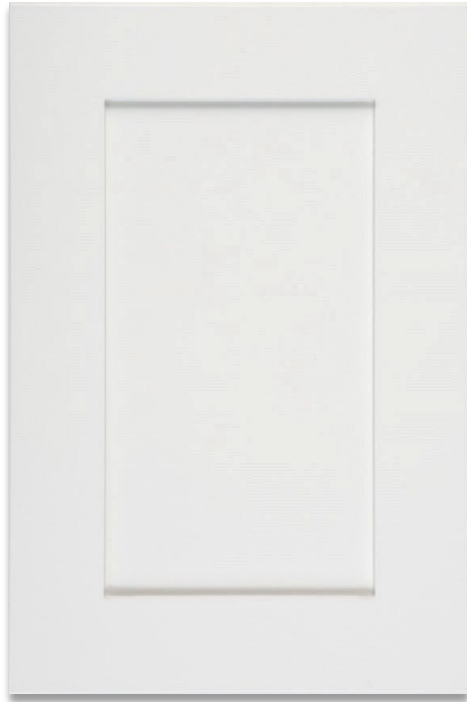

S O H O

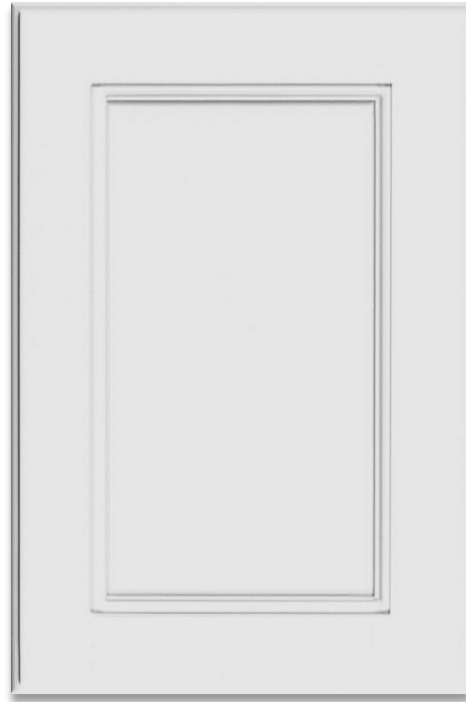

V E N E Z I A



O D Y S S E Y



NAVY BLUE

Line 5 - Maple Upgrade

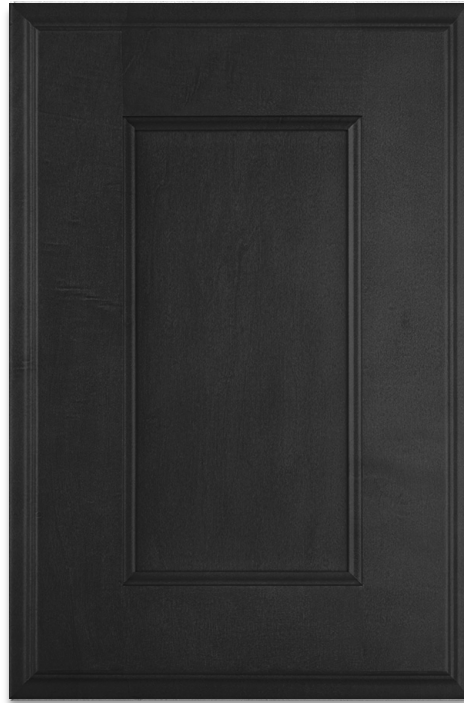

NEWPORT

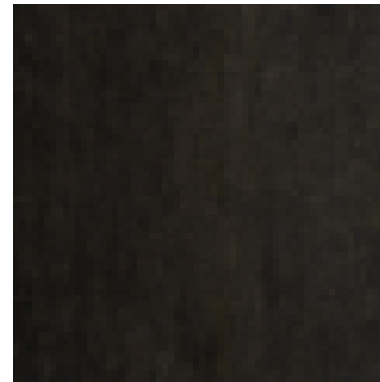

PEPPER

Line 5 - Painted Upgrade



E U R O P A



N E W P O R T



A U R O R A



N A V Y B L U E

Included Cabinet Hardware



HN 52



KN 42



HN 53



KN 43



HN 56



KN 51



Cabinet Hardware Upgrade - Level 1



HU 110



HU 120



HU 130



HU 64



HU 66

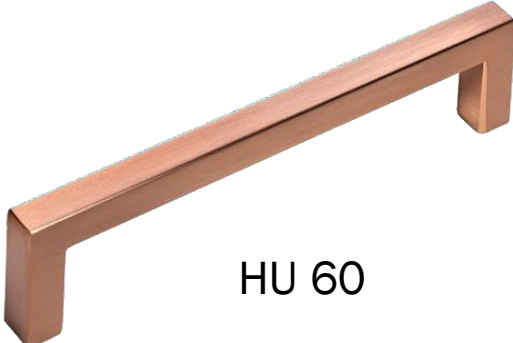

HU 60



KU 66



KU 64



KU 60



Cabinet Hardware Upgrade - Level 2

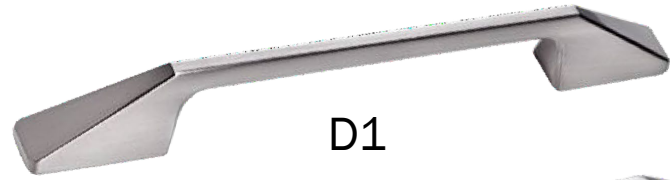

D1

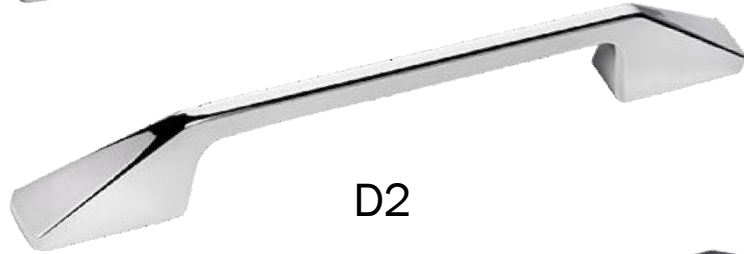

D2



D3

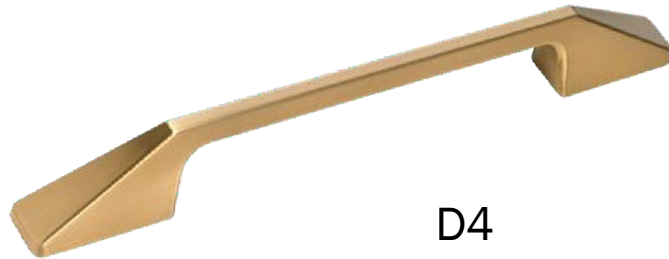

D4



D5



D6



D7



D10



D9



D8





Countertop Options

Included Quartz

where applicable
as per Schedule A



ROCKY SHORES



BLACKBURN

Included countertop material varies according to community, product type and room. Please consult *Agreement of Purchase and Sale - Schedule A* for confirmation of exact standard material/s specified for your home.

Included Granite

where applicable
as per Schedule A



BIANCO SARDO



NEW CALEDONIA



UBA TUBA

Included Laminate

where applicable
as per Schedule A



CALACATTA MARBLE

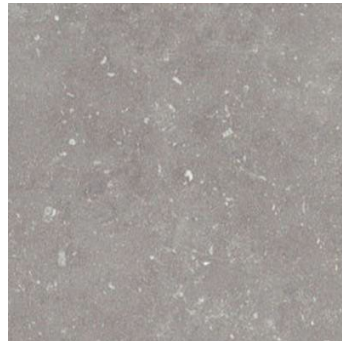

INUKSHUK GREY



ITALIAN WHITE DI PESCO



INUKSHUK CARBON

Group A Upgrade

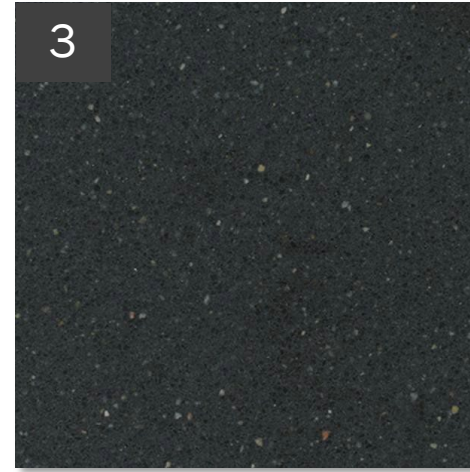

1. BLANCO MAPLE
2. LENA
3. TEBAS BLACK
4. GREY EXPO
5. MARENGO

Group B Upgrade

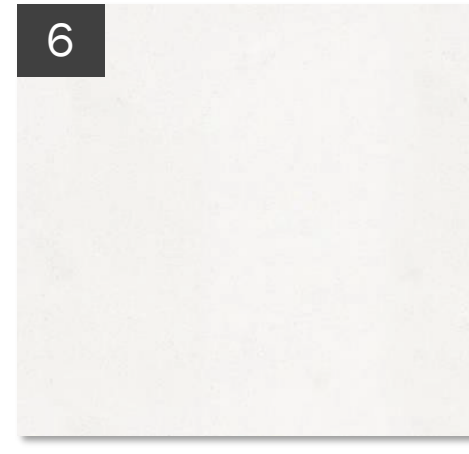
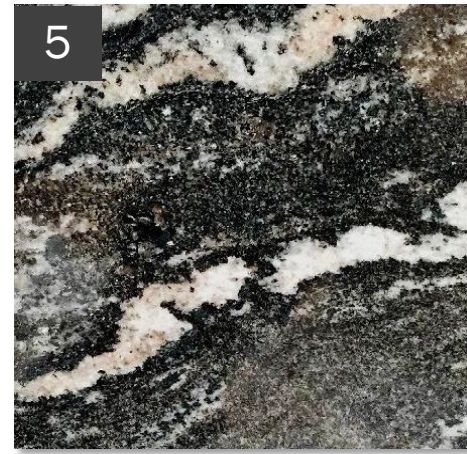
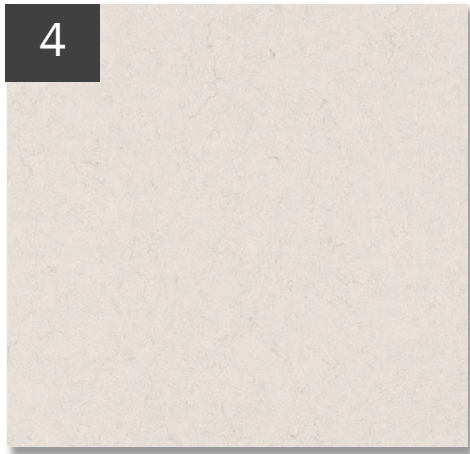
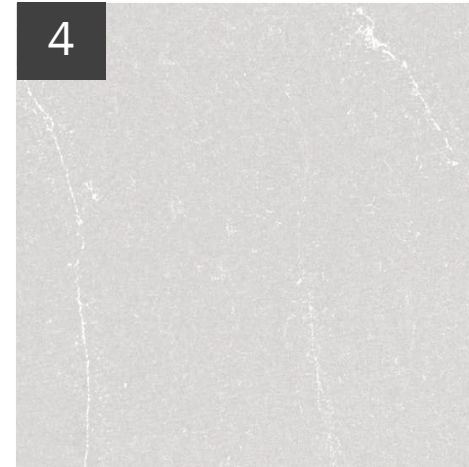

1. CLAMSHELL
2. SNOWY IBIZA
3. DESERT SILVER
4. RIVERLET
5. SILVER PARADISO GRANITE
6. WHITE ZEUS EXTREME

Group C Upgrade

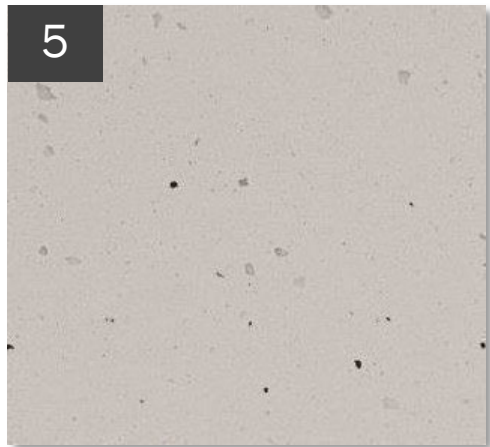
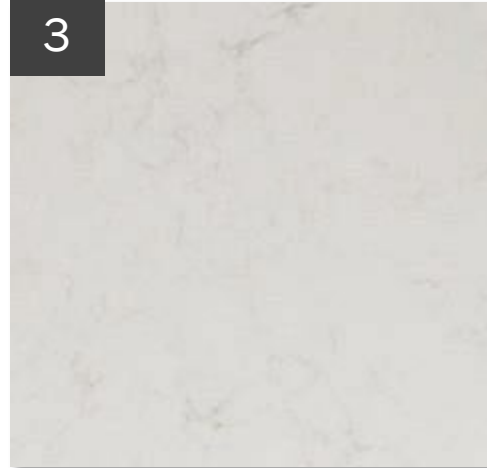
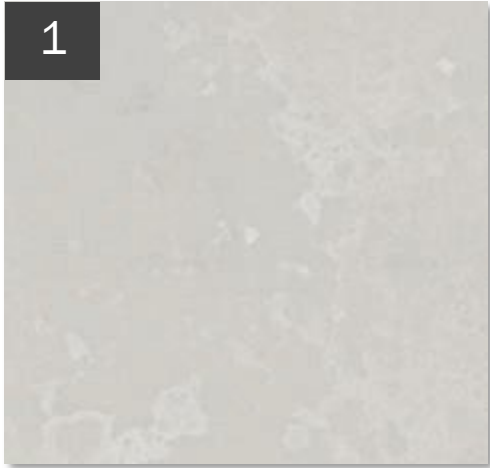

1. CLOUDBURST CONCRETE
2. COSMOPOLITAN WHITE
3. FROSTY CARINA
4. RAINDREAM
5. FROZEN TERRA
6. WHITE ARABESQUE
7. SLEEK CONCRETE

Group C Upgrade

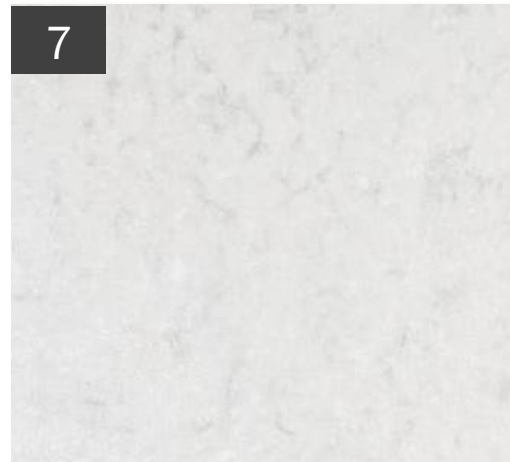
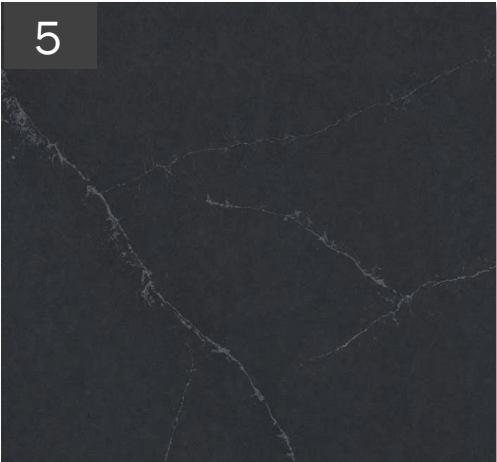
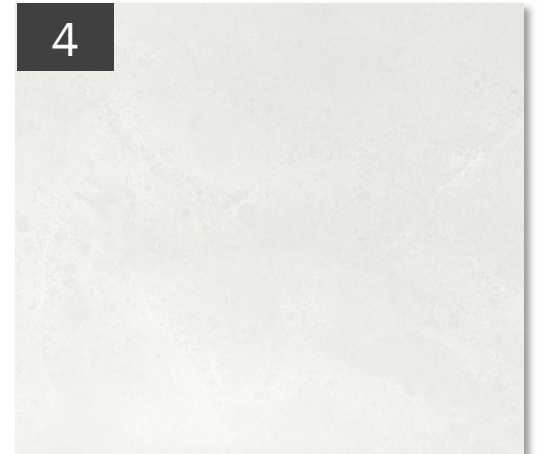
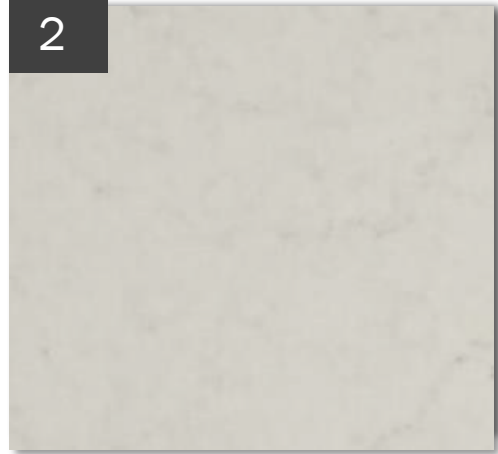
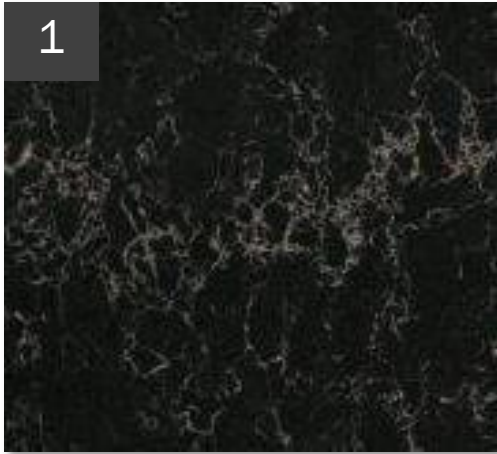

1. VANILLA NOIR
2. LONDON GREY
3. TITANIUM GRANITE
4. NOLITA SUEDE
5. CHARCOAL SOAPSTONE
6. PEARL JASMINE
7. LAGOON

Group D Upgrade

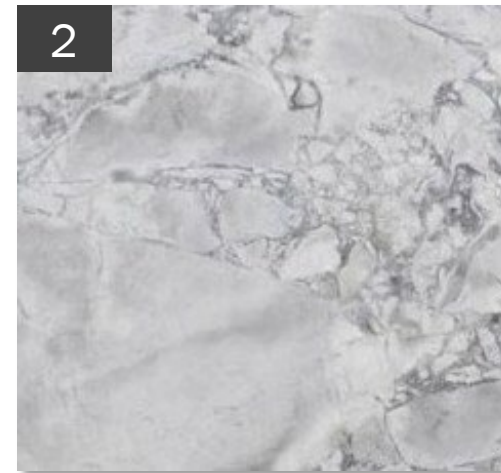
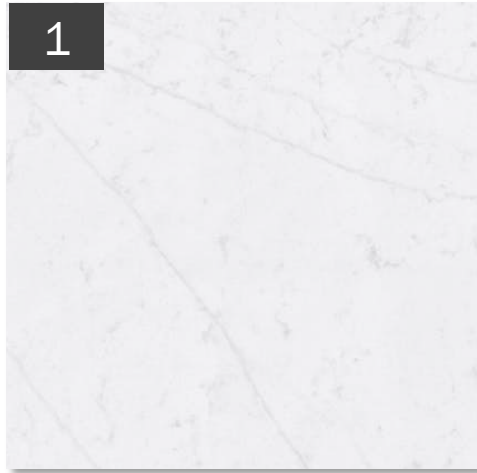

1. ETERNAL STATUARIO
2. SUPERWHITE GRANITE

Group E Upgrade

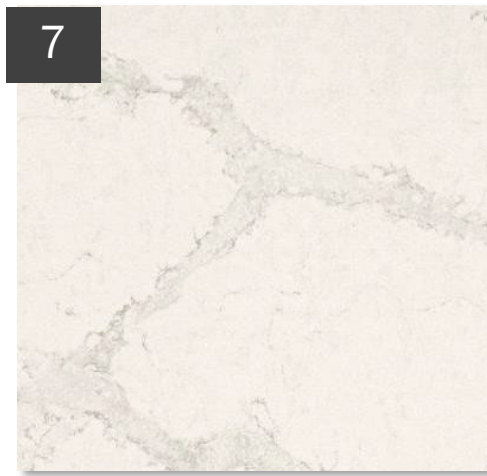
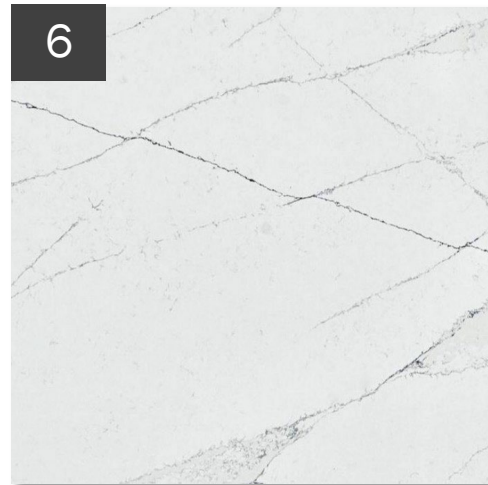
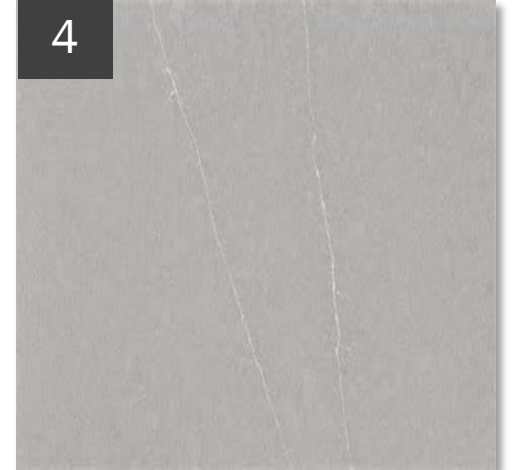
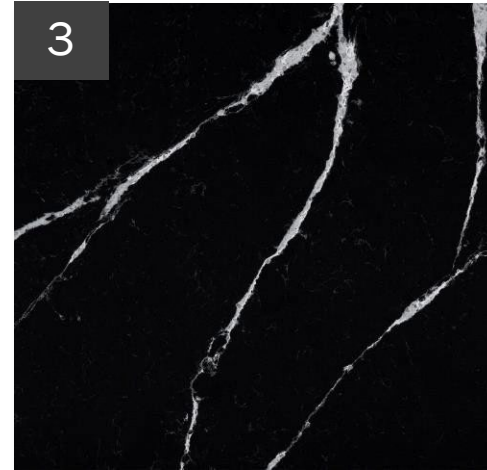

1. INFINITY WHITE GRANITE
2. ETERNAL BIANCO CALACATTA
3. ETERNAL MARQUINA
4. ETERNAL SERENA
5. CALACATTA GOLD POLISHED
6. ETHEREAL NOCTIS
7. CALACATTA NUOVO



Floor Tile Options

Included Floor Tiles

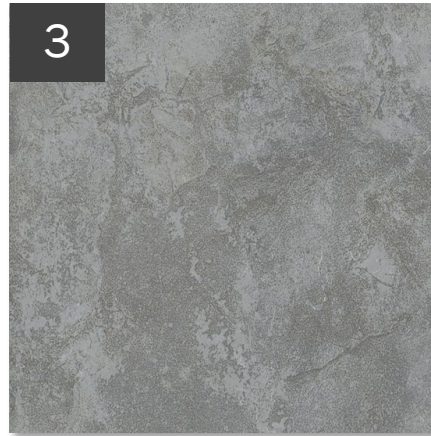
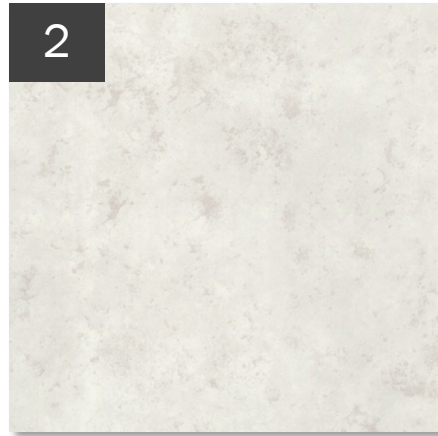

1. 13 x 13 ALPES WHITE
2. 13 x 13 TUSCANY BONE
3. 13 x 13 ALPES GREY
4. 13 x 13 ETHEREAL SAND GREY
5. 13 x 13 EXPLORER LONDON
6. 13 x 13 CORTE MILIA CASABLANCA

Group A Upgrade Floor Tiles

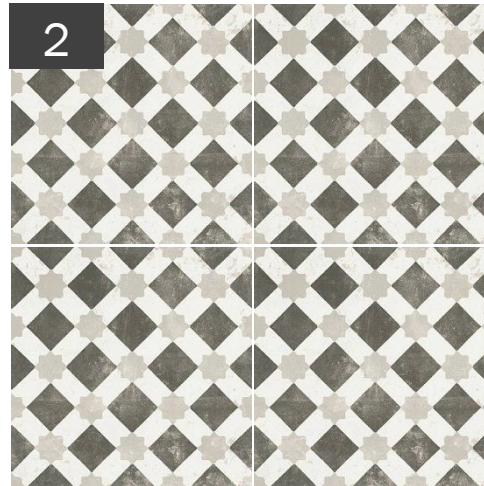

1. 8 x 8 VINTAGE DECORO 4
2. 8 x 8 VINTAGE DECORO 11
3. 18 X 18 MADISON WHITE

Group A Upgrade Floor Tiles



1. 12 X 24 CALACATTA BORGHINI MATTE
2. 12 x 24 SPLENDID WHITE CLOUD
3. 12 x24 WESTSIDE GREY MATTE

2/24/2023

Mattamy Homes reserves the right to change the offerings at any time. Photography for representational purposes only. Prices are inclusive of Applicable Taxes and are subject to change without notice. The Vendor attempts to be as accurate as possible when describing its products in the digital catalogue. However, to the extent permitted by applicable law, Vendor does not warrant that the product descriptions, colors, textures, information or other content in the digital catalogue are accurate, complete, reliable, current, or error-free. E & OE.

Group B Upgrade Floor Tiles

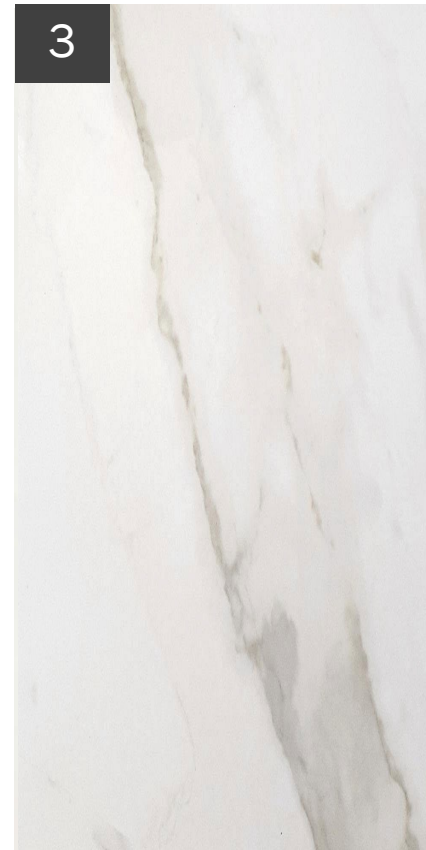
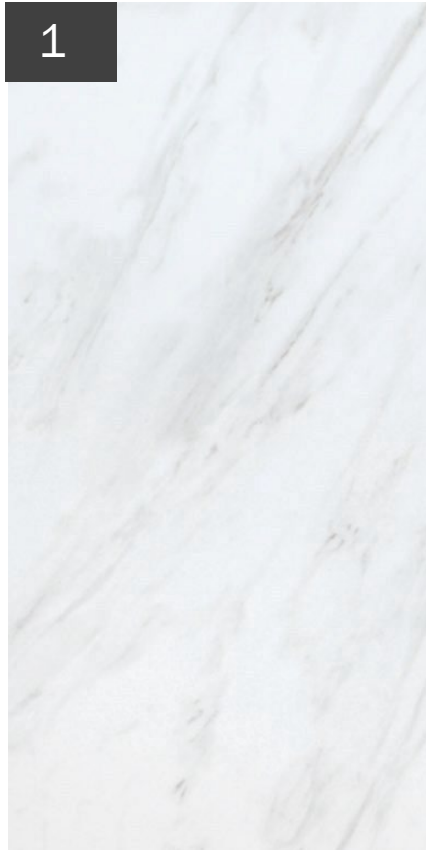

1. 12 X 24 ETERNA VOLKAS WHITE POLISHED

**also available in MATTE*

2. 12 X 24 ETERNA CALACATTA GREY POLISHED

3. 12 x 24 ETERNA CALACATTA TAUPE POLISHED

4. 12 x24 ETERNA NERO MARQUINA MATTE

Group B Upgrade Floor Tiles



1. 12 X 24 FRAY WHITE MATTE
2. 12 X 24 FRAY PEARL MATTE

Group B Upgrade Floor Tiles



1. 6 x 36 LAKELAND BLANCO
2. 6 x 36 LAKELAND HAYA

Group C Upgrade Floor Tiles

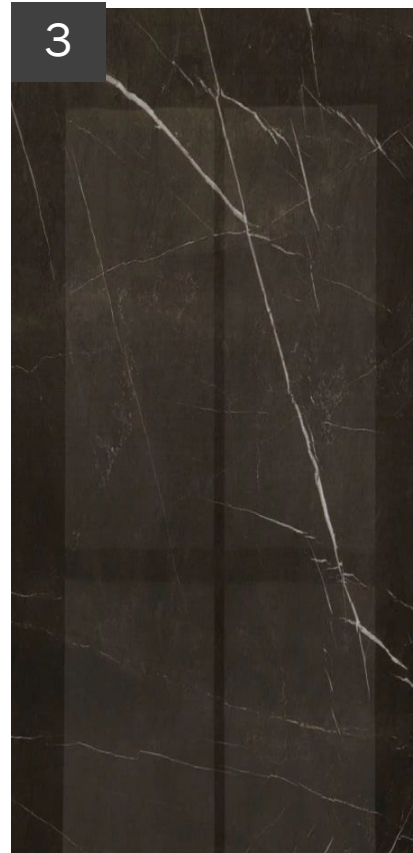

- 1. 12 X 24 TIMELESS WHITE POLISHED
- 2. 12 x 24 NOLITA BIANCO HONED

- 3. 12 x 24 GATSBY CABARET POLISHED
- 4. 7 x 8 HEXATILE BLANCO

Group D Upgrade Floor Tiles

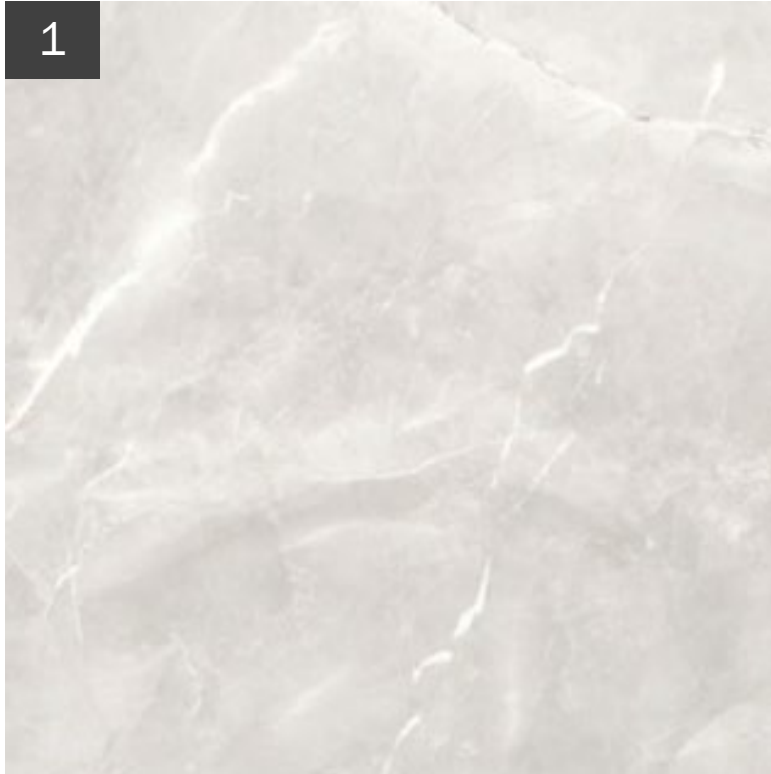

1. 24 X 24 RODUM PERLA MATTE
2. 24 X 24 PINCH WHITE MATTE
3. 24 x 24 URBANCRETE MINK



Wall Tile Options

Included Wall Tiles

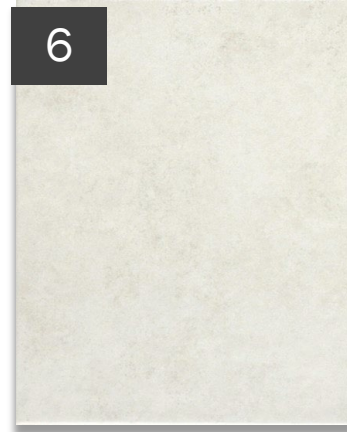
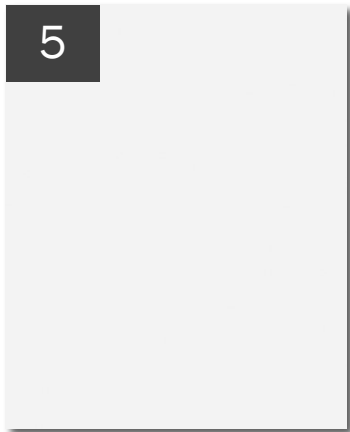
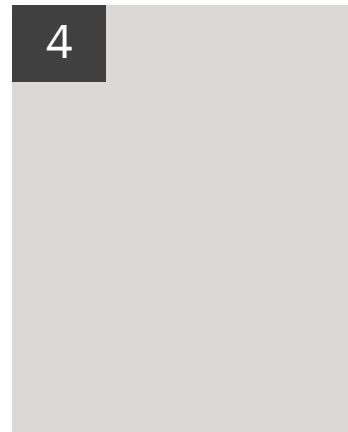
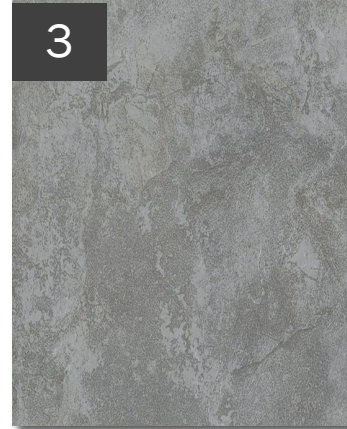
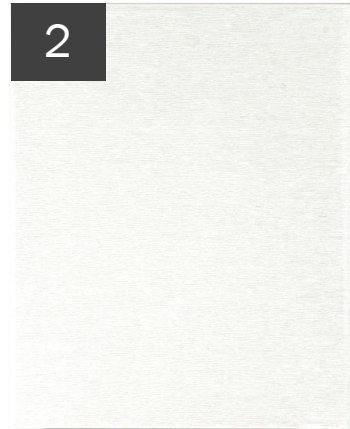

1. 8 x 10 ALPES WHITE
2. 8 x 10 SPLENDOUR WHITE
3. 8 x 10 ALPES GREY
4. 8 x 10 UNIWALL TENDER GREY
5. 8 x 10 UNIWALL WHITE
6. 8 x 10 CORTE MILIA CASABLANCA

Group A Upgrade Wall Tiles



10 X 16 LINDT SERIES WHITE GLOSSY



4 x 12 CHESS BEVELLED GLOSSY COLLECTION:

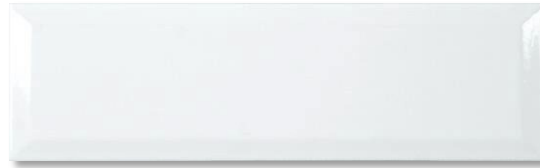

ARCTIC WHITE



TENDER GREY



DARK GREY

4 x 16 COLOR & DIMENSION COLLECTION:

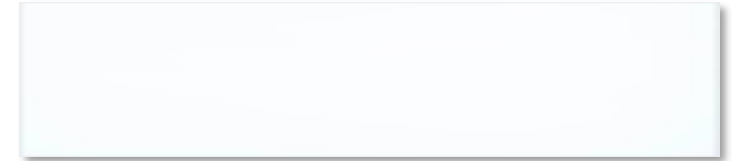

ARCTIC WHITE MATTE



TENDER GREY GLOSSY

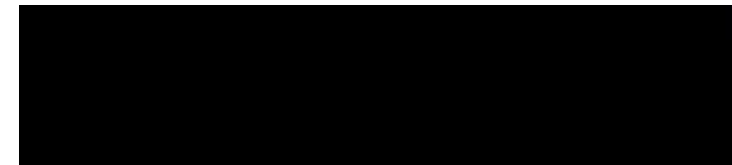

BLACK GLOSSY

Group A Upgrade Wall Tiles



1. 12 X 24 CALACATTA BORGHINI MATTE
2. 12 x 24 SPLENDID WHITE CLOUD
3. 12 x24 WESTSIDE GREY MATTE

2/24/2023

Mattamy Homes reserves the right to change the offerings at any time. Photography for representational purposes only. Prices are inclusive of Applicable Taxes and are subject to change without notice. The Vendor attempts to be as accurate as possible when describing its products in the digital catalogue. However, to the extent permitted by applicable law, Vendor does not warrant that the product descriptions, colors, textures, information or other content in the digital catalogue are accurate, complete, reliable, current, or error-free. E & OE.



Group A Upgrade Wall Tiles



8 x 24 DUOMO BLANCO BRIGHT



10 x 22 SPLENDID WHITE CLOUD BRIGHT



Group B Upgrade Wall Tiles

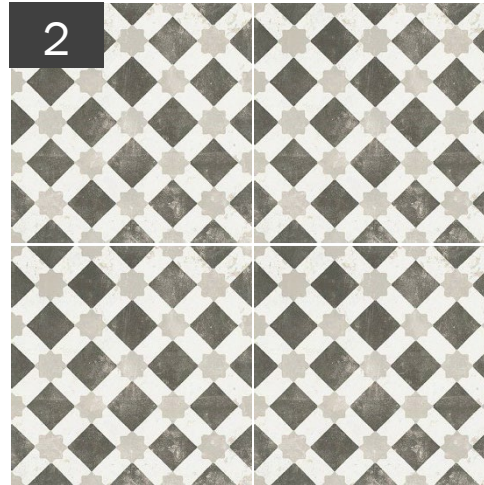

1. 8 x 8 VINTAGE DECORO 4
2. 8 x 8 VINTAGE DECORO 11
3. 18 X 18 MADISON WHITE

Group B Upgrade Wall Tiles



2.5 x 8 LA RIVIERA COLLECTION:



BLANC



GRIS NUAGE

4 x 12 PICCADILLY GLOSSY COLLECTION:



BIANCO

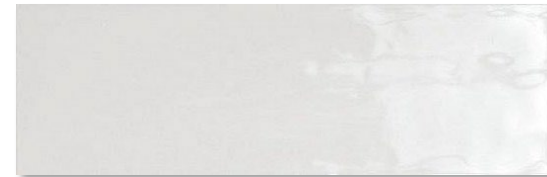

PEARL



AVORIO

Group B Upgrade Wall Tiles



1. 12 X 24 FRAY WHITE MATTE
2. 12 X 24 FRAY PEARL MATTE
3. 6 x 36 LAKELAND BLANCO
4. 6 x 36 LAKELAND HAYA

Group C Upgrade Wall Tiles

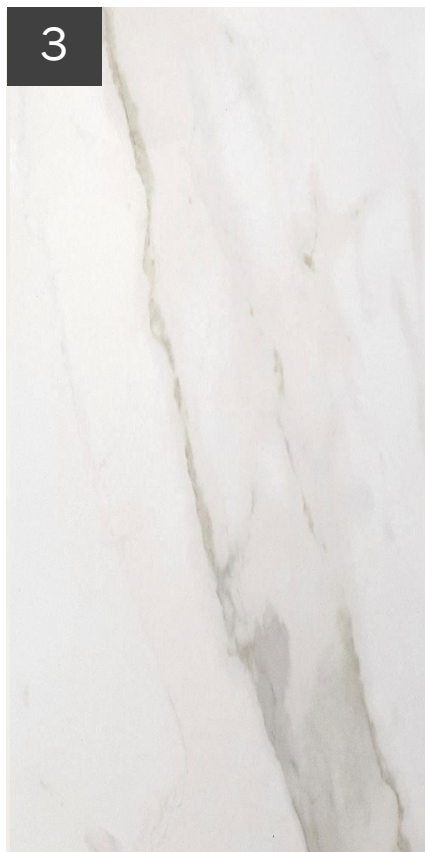
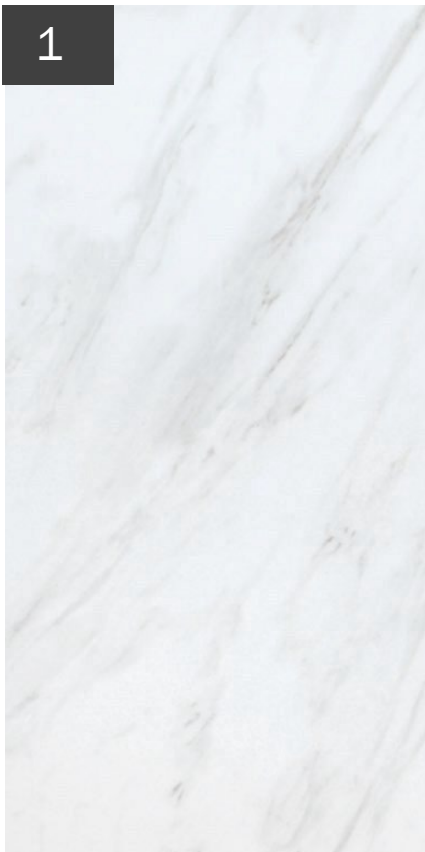

1. 12 X 24 ETERNA VOLKAS WHITE POLISHED

**also available in MATTE*

2. 12 X 24 ETERNA CALACATTA GREY POLISHED

3. 12 x 24 ETERNA CALACATTA TAUPE POLISHED

4. 12 x24 ETERNA NERO MARQUINA MATTE

Group C Upgrade Wall Tiles



1. 12 X 24 TIMELESS WHITE POLISHED
2. 12 x 24 GATSBY CABARET POLISHED

Group C Upgrade Wall Tiles



1



2

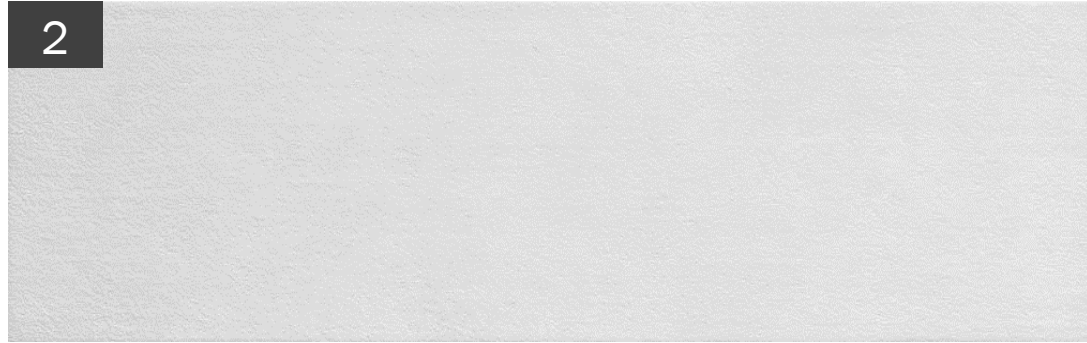

3



4



1. 2 X 6 HERRINGBONE ETERNA VOLKAS WHITE POLISHED
2. 10 x 30 MAT & MORE WHITE MATTE
3. 10 x 30 MAT & MORE GREY MATTE
4. 10 x 30 ROMA STATUARIO FILO 3D DÉCOR MATTE

Group D Upgrade Wall Tiles



1

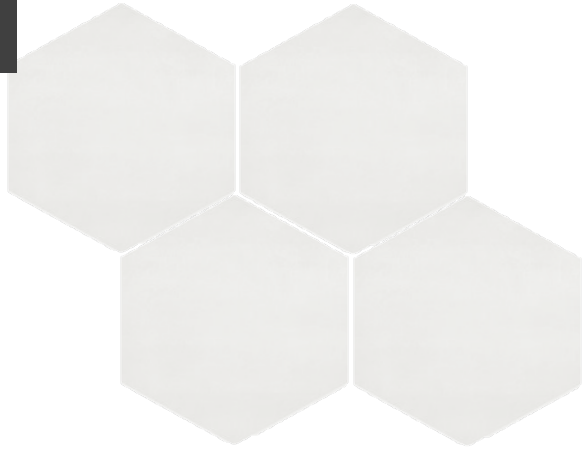

2

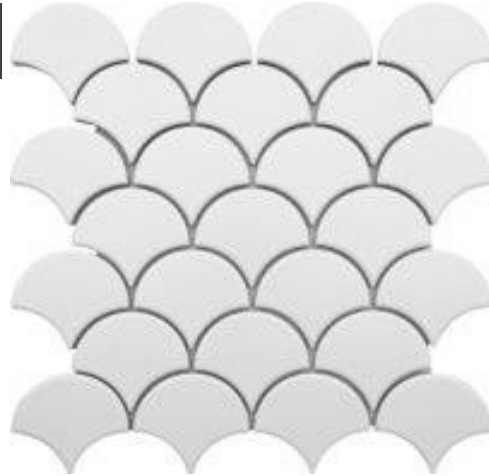

3



4



5



1. 7 X 8 HEXATILE BLANCO
2. 11.65 X 12.25 FAN WHITE GLOSSY
3. 1 X 3 HERRINGBONE ETERNA NERO MARQUINA POLISHED
4. 8 X 24 VETRI BIANCO POLISHED
5. 12 x 24 NOLITA BIANCO HONED

Backsplash Options



2/24/2023

Group A Upgrade Backsplash



4 x 12 CHESS BEVELLED GLOSSY COLLECTION:

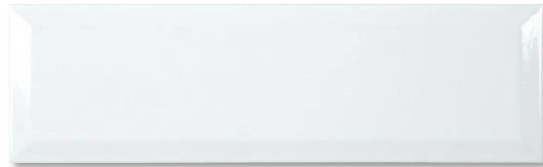

ARCTIC WHITE



TENDER GREY



DARK GREY

3 x 6 COLOR & DIMENSION
ARCTIC WHITE MATTE

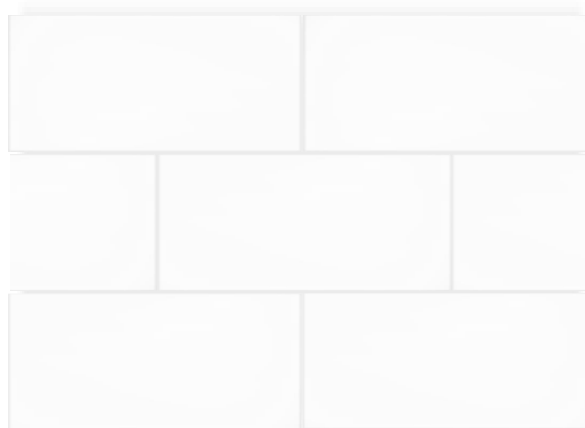

3 x 6 COLOR & DIMENSION
TENDER GREY MATTE



Group A Upgrade Backsplash



4 x 12 PICCADILLY GLOSSY COLLECTION:



BIANCO

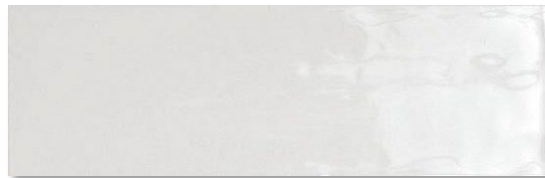

PEARL



AVORIO

2.5 x 8 LA RIVIERA COLLECTION:



BLANC



GRIS NUAGE

Group B Upgrade Backsplash



11.65 X 12.25 FAN WHITE GLOSSY



3 X 13 SFUMATURE DÉCOR WHITE GLOSSY

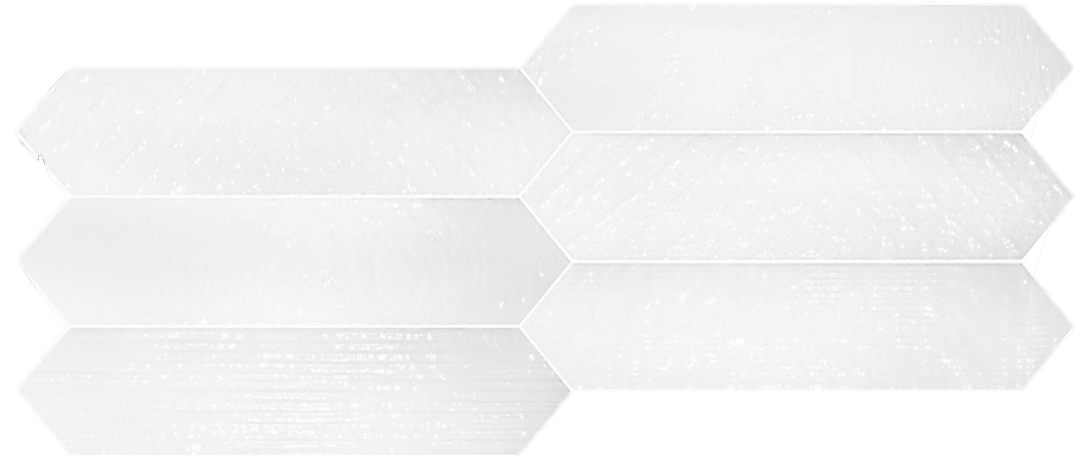

3 X 13 SFUMATURE GRIGIO GLOSSY

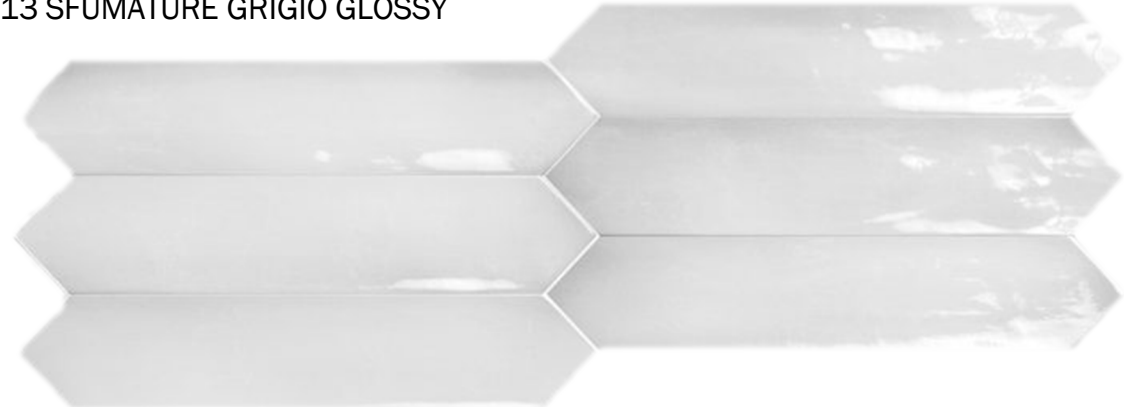

Group B Upgrade Backsplash



PENNY ROUND SNOW WHITE GLOSSY

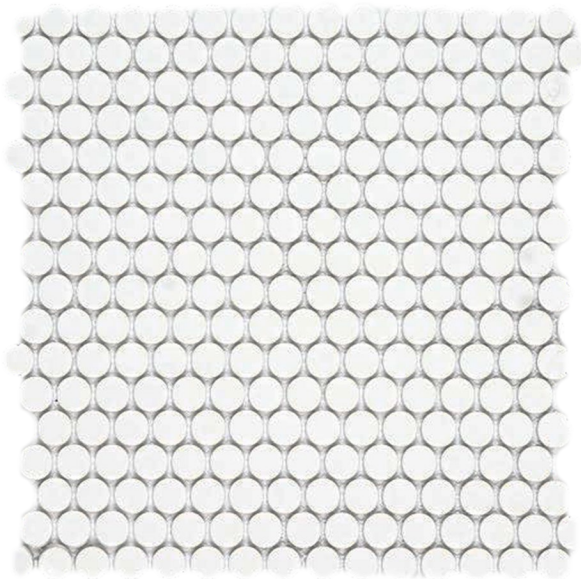

1 x 3 TECHNO SPECIAL WHITE

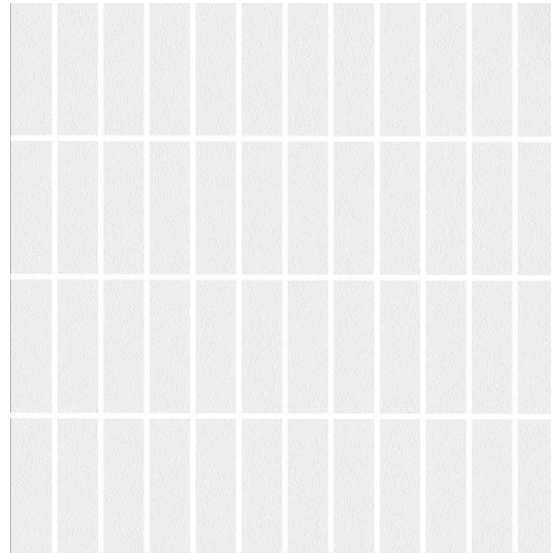

1 x 3 TECHNO SLATE GREY

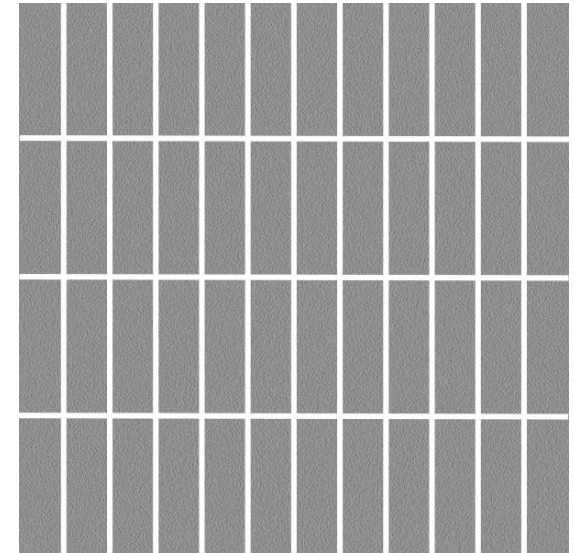

Group C Upgrade Backsplash

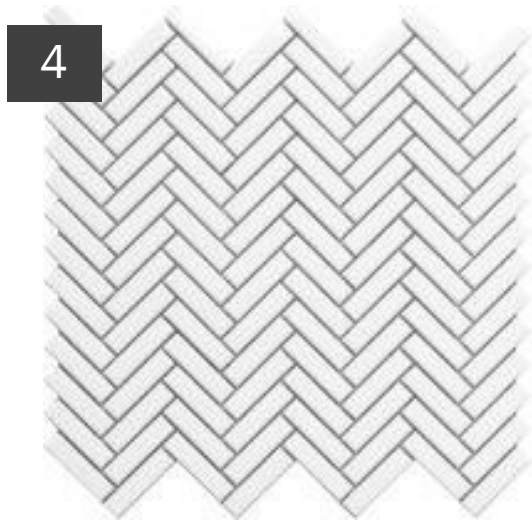
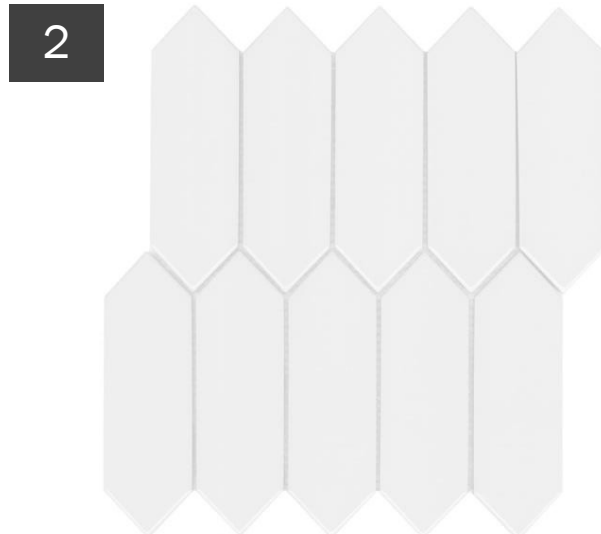

1. 2 X 6 ETERNA HERRINGBONE VOLKAS WHITE POLISHED
2. 2 X 6 PICKET WHITE GLOSSY
3. 4" MIKI INKJET HEXAGON CARRARA WHITE MATTE
4. 12 X 12 HERRINGBONE WHITE GLOSSY
5. 1 X 3 HERRINGBONE ETERNA NERO MARQUINA POLISHED

Mattamy Homes reserves the right to change the offerings at any time. Photography for representational purposes only. Prices are inclusive of Applicable Taxes and are subject to change without notice. The Vendor attempts to be as accurate as possible when describing its products in the digital catalogue. However, to the extent permitted by applicable law, Vendor does not warrant that the product descriptions, colors, textures, information or other content in the digital catalogue are accurate, complete, reliable, current, or error-free. E & OE.



Group D Upgrade Backsplash



MARBLE CHEVRON MOSAIC
ORIENTAL WHITE POLISHED



Shower Mosaic Options

Group A Upgrade Shower Floor Mosaic

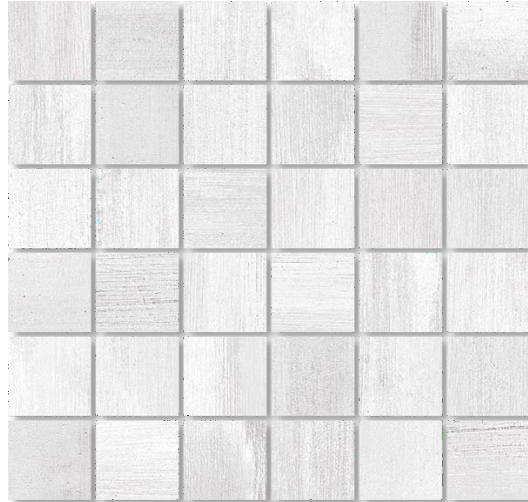

2 x 2 SAVONA BIANCO MATTE

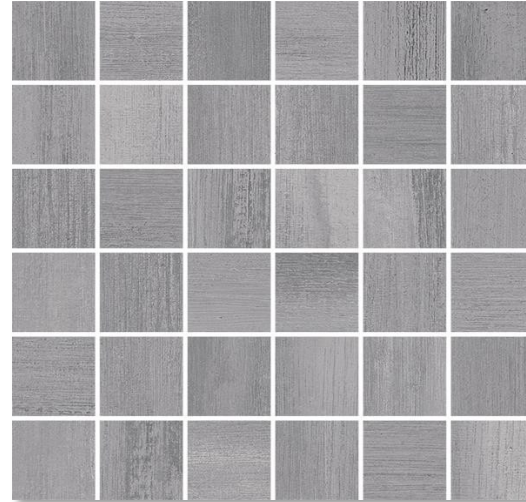

2 x 2 SAVONA ASH MATTE

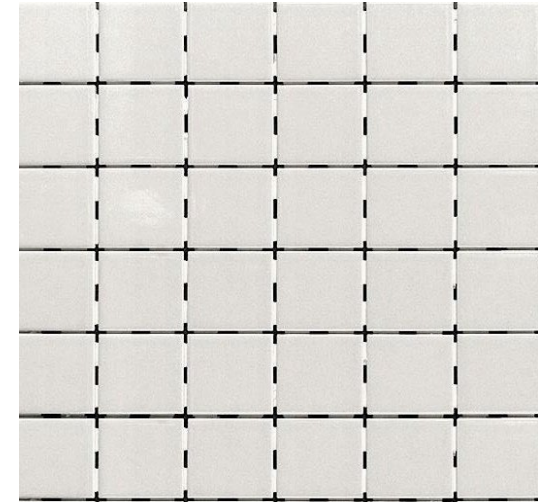

2 X 2 ONTARIO TENDER GREY MATTE

Group B Upgrade Shower Floor Mosaic

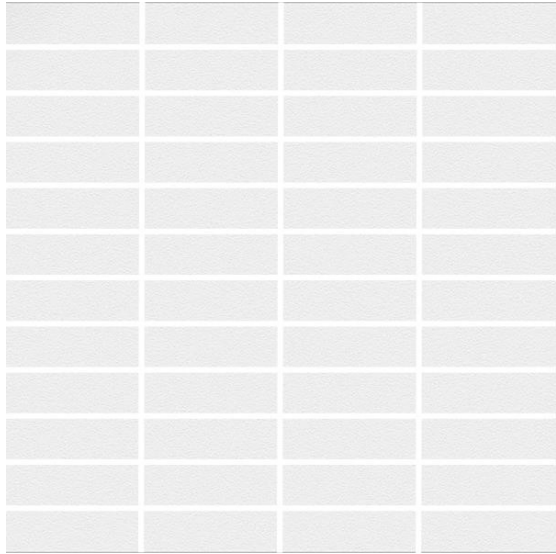

1 x 3 TECHNO SPECIAL WHITE

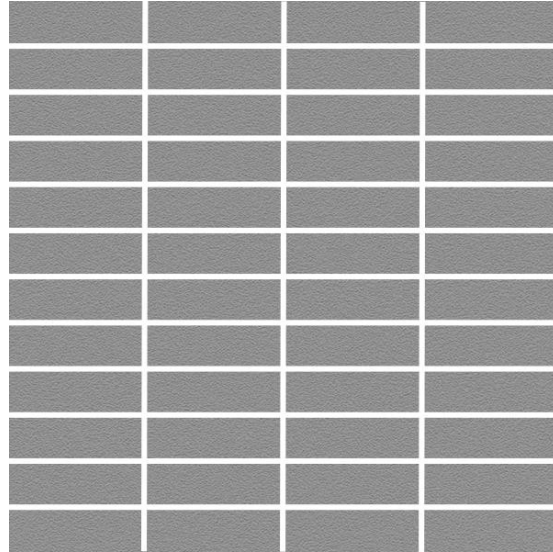

1 x 3 TECHNO SLATE GREY

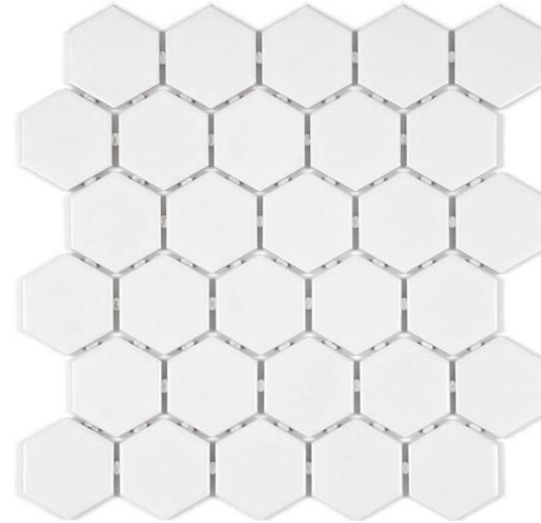

ONTARIO HEX SNOW WHITE MATTE



ONTARIO HEX DARK GREY MATTE

Group C Upgrade Shower Floor Mosaic

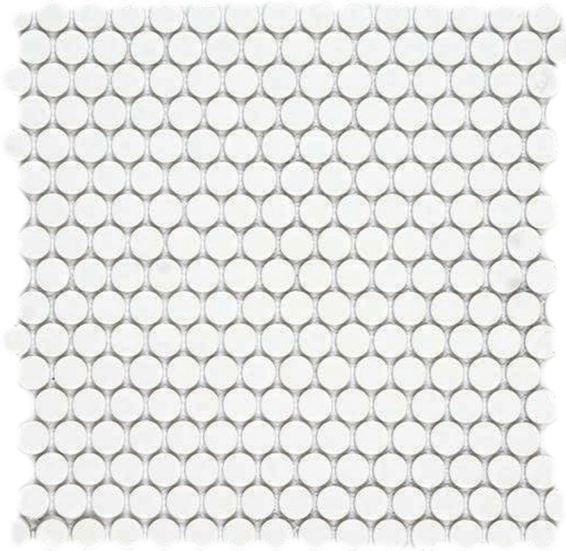

PENNY ROUND SNOW WHITE GLOSSY



2 X 2 ETERNA CALACATTA GREY
POLISHED



2 X 2 ETERNA CALACATTA TAUPE
POLISHED

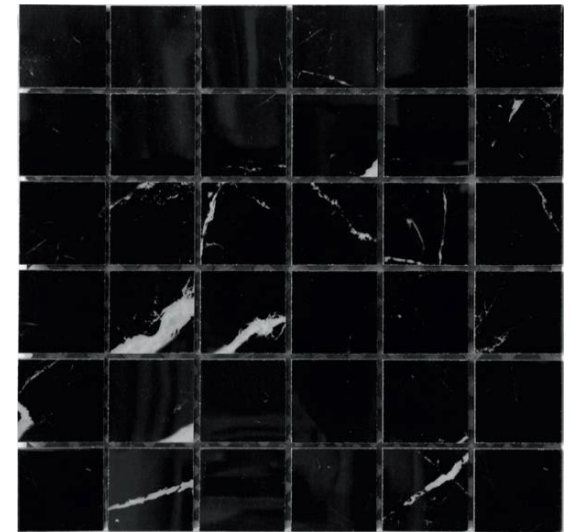

2 X 2 ETERNA NERO MARQUINA
MATTE

Group E Upgrade Shower Floor Mosaic

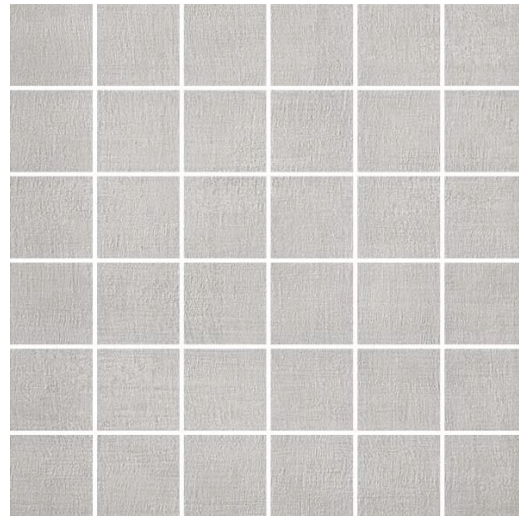

2 x 2 FRAY PEARL MATTE



Feature Wall Options

Group A Feature Wall Tiles



1. 12 X 24 FRAY WHITE MATTE
2. 12 X 24 FRAY PEARL MATTE
3. 6 x 36 LAKELAND BLANCO
4. 6 x 36 LAKELAND HAYA

Group A Feature Wall Tiles



1. 12 X 24 CALACATTA BORGHINI MATTE
2. 12 x 24 SPLENDID WHITE CLOUD
3. 12 x24 WESTSIDE GREY MATTE

2/24/2023

Mattamy Homes reserves the right to change the offerings at any time. Photography for representational purposes only. Prices are inclusive of Applicable Taxes and are subject to change without notice. The Vendor attempts to be as accurate as possible when describing its products in the digital catalogue. However, to the extent permitted by applicable law, Vendor does not warrant that the product descriptions, colors, textures, information or other content in the digital catalogue are accurate, complete, reliable, current, or error-free. E & OE.

Group A Feature Wall Tiles



8 x 8 VINTAGE DECORO 4

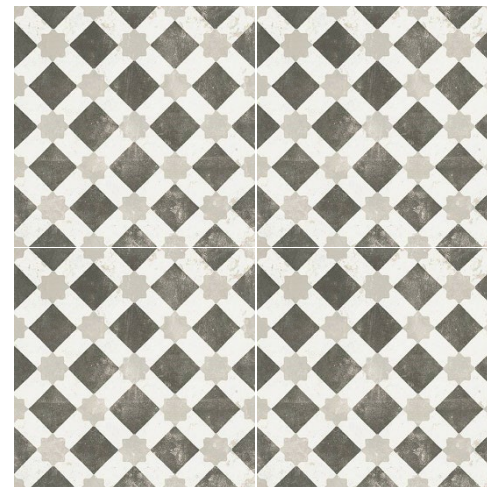

8 x 8 VINTAGE DECORO 11

2/24/2023

Mattamy Homes reserves the right to change the offerings at any time. Photography for representational purposes only. Prices are inclusive of Applicable Taxes and are subject to change without notice. The Vendor attempts to be as accurate as possible when describing its products in the digital catalogue. However, to the extent permitted by applicable law, Vendor does not warrant that the product descriptions, colors, textures, information or other content in the digital catalogue are accurate, complete, reliable, current, or error-free. E & OE.

Group B Feature Wall Tiles



2.5 x 8 LA RIVIERA BLANC



2.5 x 8 LA RIVIERA GRIS NUAGE

2/24/2023

Mattamy Homes reserves the right to change the offerings at any time. Photography for representational purposes only. Prices are inclusive of Applicable Taxes and are subject to change without notice. The Vendor attempts to be as accurate as possible when describing its products in the digital catalogue. However, to the extent permitted by applicable law, Vendor does not warrant that the product descriptions, colors, textures, information or other content in the digital catalogue are accurate, complete, reliable, current, or error-free. E & OE.



Group B Feature Wall Tiles

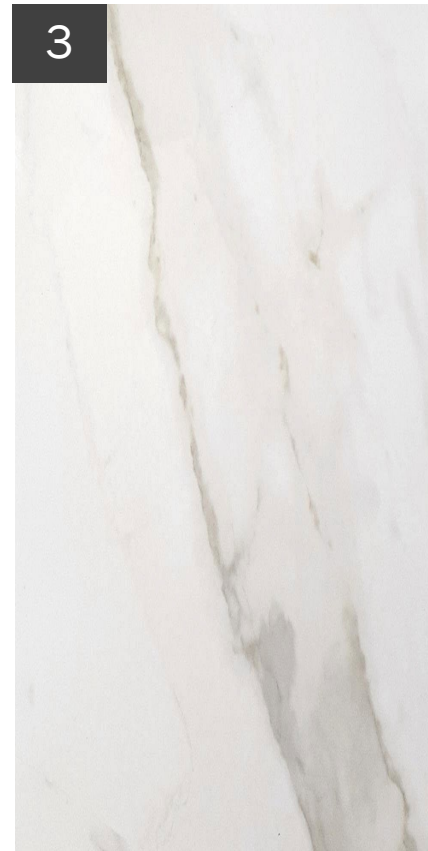
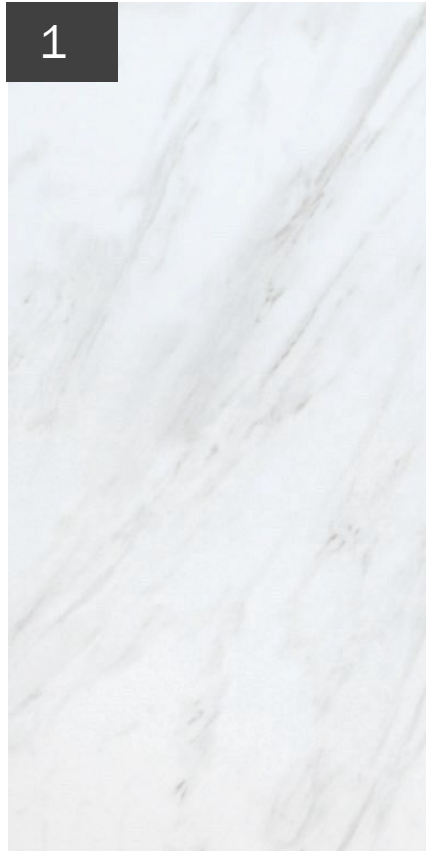

1. 12 X 24 ETERNA VOLKAS WHITE POLISHED
**also available in MATTE*

2. 12 X 24 ETERNA CALACATTA GREY POLISHED
3. 12 X 24 ETERNA CALACATTA GREY POLISHED

4. 12 x 24 ETERNA NERO MARQUINA MATTE

Group C Feature Wall Tiles

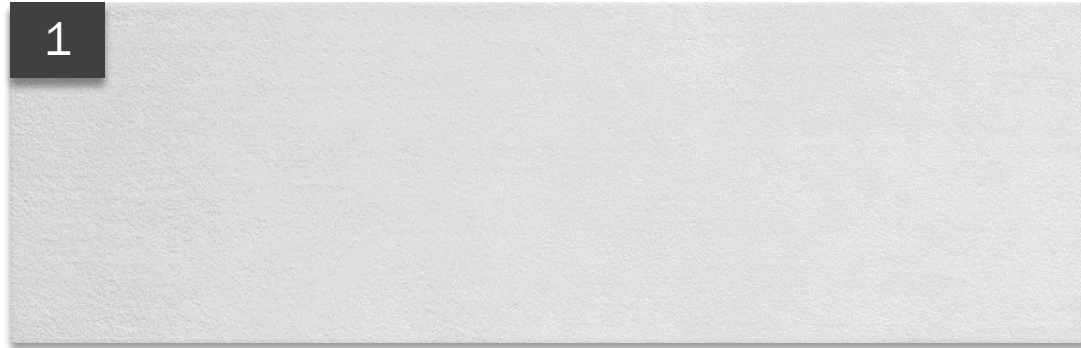

1. 10 x 30 MAT & MORE WHITE MATTE
2. 10 x 30 MAT & MORE GREY MATTE
3. 10 x 30 ROMA STATUARIO FILO 3D DÉCOR MATTE

Group C Feature Wall Tiles

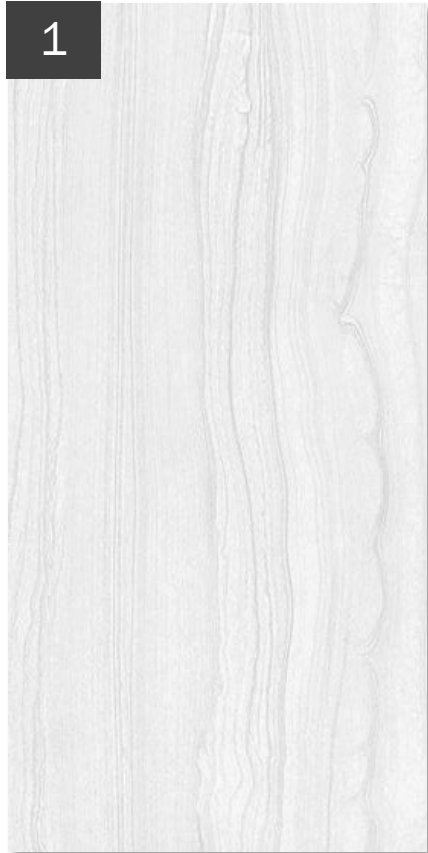

1. 12 X 24 TIMELESS WHITE POLISHED
2. 12 x 24 NOLITA BIANCO HONED
3. 12 x 24 GATSBY CABARET POLISHED

Group D Feature Wall Tiles

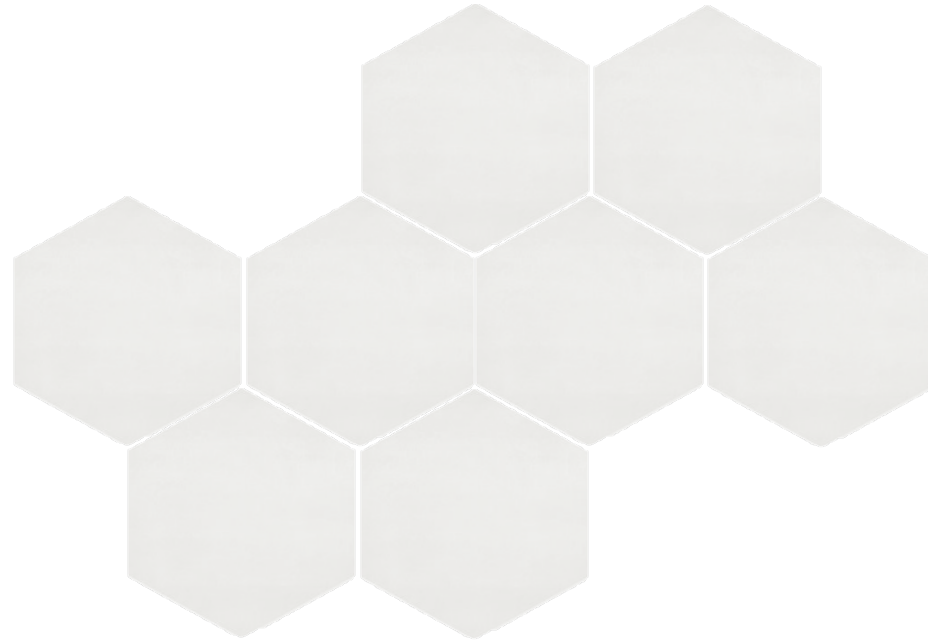

7 X 8 HEXATILE BLANCO



Flooring Options

KENTWOOD ABODE
3-1/2" OAK

Included Hardwood

*where applicable
as per Schedule A*



NATURAL



TEA LEAF



POCKET WATCH

KENTWOOD ELEMENTS
3-1/2" OAK

Included Hardwood

*where applicable
as per Schedule A*



NATURAL



BARLEY



LYNX

GOODFELLOW DUBAI
5.83" SPC - LVT

Included LVT

*where applicable
as per Schedule A*



PALM BEACH



BATHSHEBA



HARBOUR ISLAND

Included flooring material and color options vary according to community, product type and room. Please consult *Agreement of Purchase and Sale - Schedule A* for confirmation of exact standard material/s specified for your home.

Laminate & Luxury Vinyl Options



Included LVT – Goodfellow

(where applicable as per Schedule A)



1. GOODFELLOW DUBAI – HARBOUR ISLAND



2. GOODFELLOW DUBAI - BATHSHEBA



3. GOODFELLOW DUBAI – PALM BEACH

Group A - Upgrade LVT



GOODFELLOW
BRUCE LIFESEAL
'GREY HAZE'



GOODFELLOW
BRUCE LIFESEAL
'SAND AND SUN'



GOODFELLOW
BRUCE LIFESEAL
'TREE TRUNK BROWN'

Group A - Upgrade LVT



GOODFELLOW ARCTIK
'BERGEN'



GOODFELLOW ARCTIK
'BREVIK'



GOODFELLOW ARCTIK
'OSLO'



Hardwood Options

Group B - Hardwood Upgrade



LAUZON 4-1/8" GOBI



LAUZON 4-1/8" CALIZA



LAUZON 4-1/8" COBALT



LAUZON 4-1/8" TALPA



LAUZON 4-1/8" HARBOR GREY (BAY)



KENTWOOD 5" WOLVERINE 5"

Group C - Hardwood Upgrade



KENTWOOD 7-1/2" LAKESIDE



KENTWOOD 7-1/2" STEAMSHIP



KENTWOOD 5" KING SHEPHERD



KENTWOOD 7-1/2" DOCKSIDE

Group C - Hardwood Upgrade



MIRAGE 5" TREASURE



LAUZON 5-3/16" PULSA



LAUZON 4-1/8" ROCKY COAST

Group D - Hardwood Upgrade



VINTAGE 5" NAUTILUS



LAUZON 6-1/4" YORKSHIRE



VINTAGE 5" GOTHAM

Group D - Hardwood Upgrade



LAUZON 7-1/16 CAPRICCIO



VINTAGE 6-1/2" ATHENA

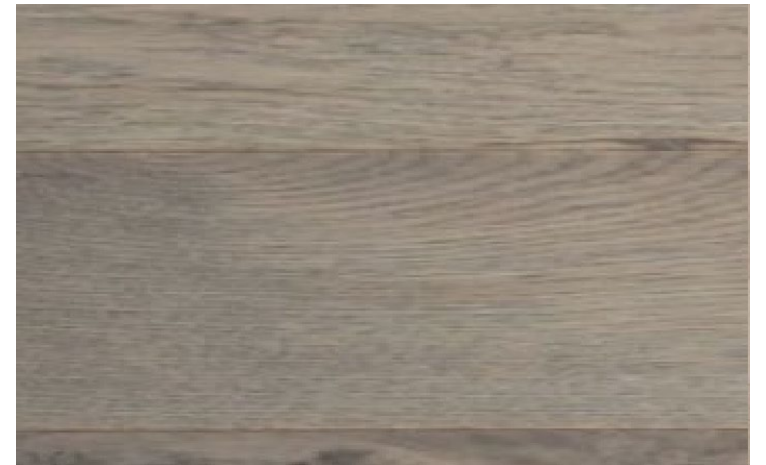

VINTAGE 6-1/2" APOLLO

Carpet Options



Included Carpet – 35 oz

(where applicable as per Schedule A)



1. SO SWEET - 04



2. SO SWEET - 03



3. SO SWEET - 21

Upgrade Mohawk - Downtown Spirt II

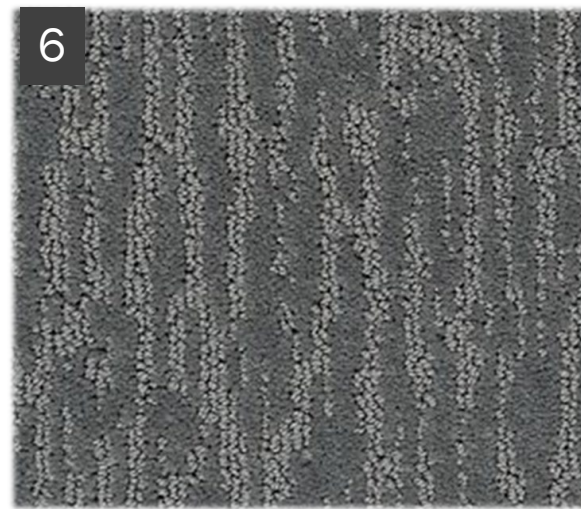
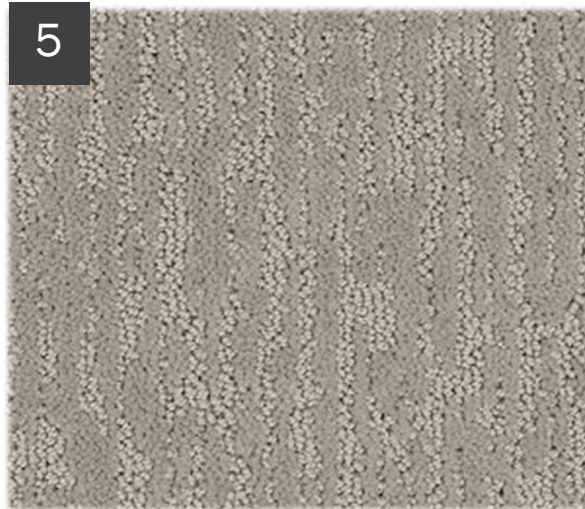
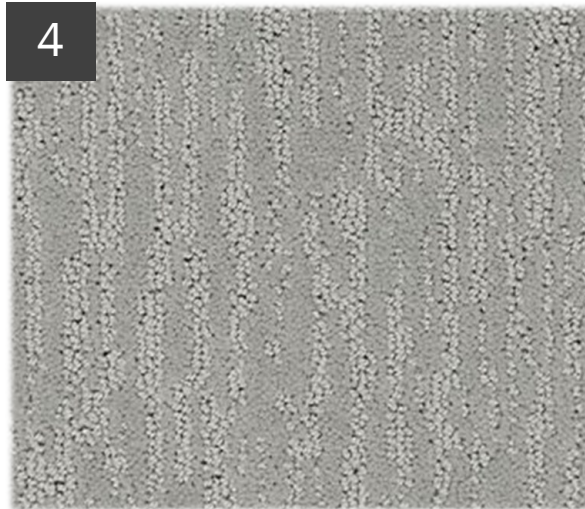
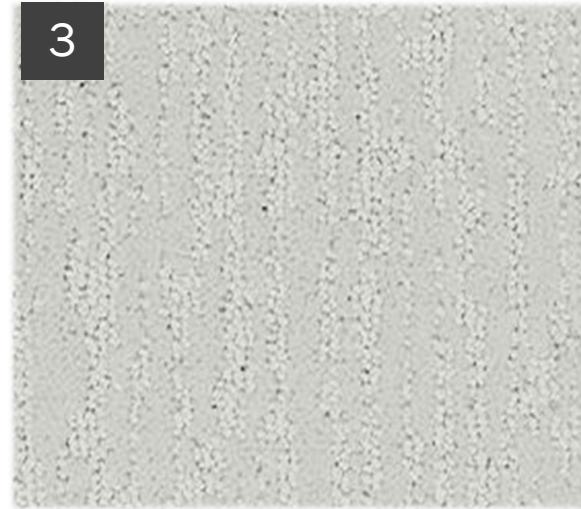
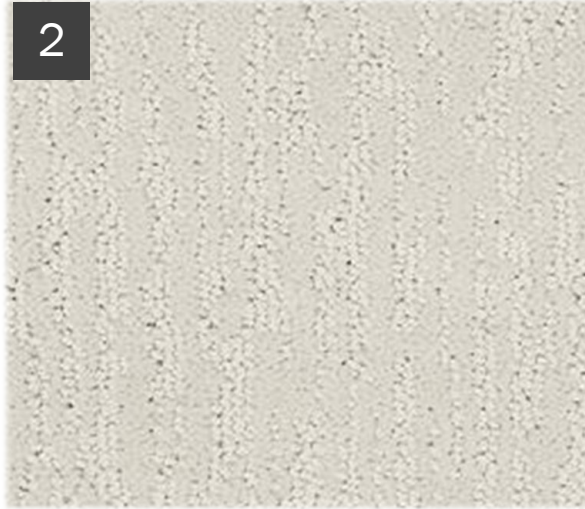

1. FRENCH VANILLA
2. SOFT ASH
3. ARCTIC AIR
4. CYBERSPACE
5. EXPLORER
6. ROLLING THUNDER

Door Options



Included Door & Hardware

(where applicable as per Schedule A)



Included
COLONIAL TEXTURED



Included
WINSTON LEVER
SATIN NICKEL



Included
EXTERIOR
HANDLE SET
SATIN NICKEL



Included
**where applicable as per Schedule A*
GARAGE TO INTERIOR
ELECTRONIC LOCK
SATIN NICKEL

Interior Door Upgrades



Carrara Smooth



Riverside

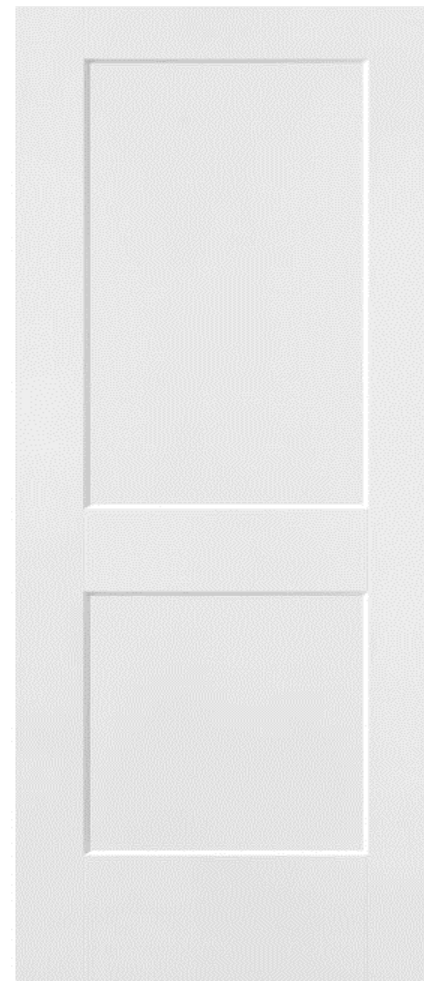

Logan

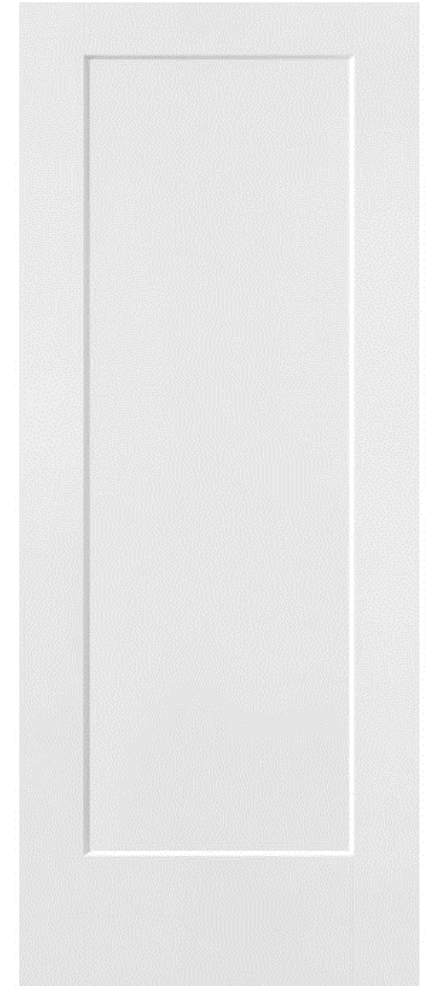

Lincoln Park

Interior Door Upgrades



Optional French Doors
for Office, Den, Mudroom, Pantry
**as permitted by plan*

**available in clear or
frosted glass*



1 Lite
80" high



1 Lite
96" high

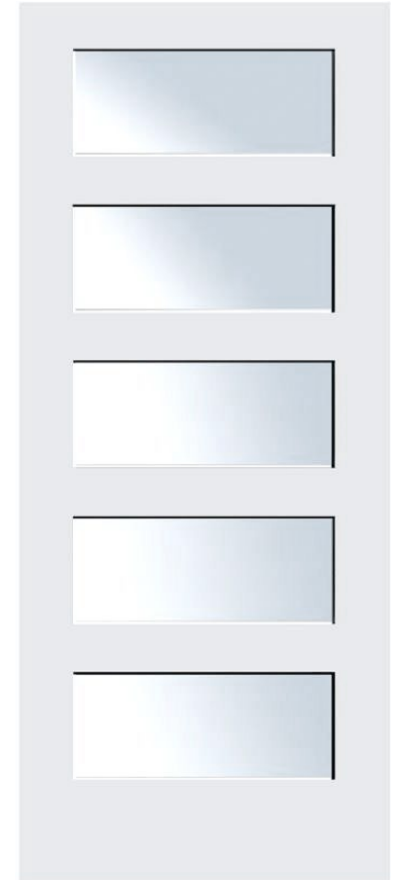

5 Lite
80" or 96" high

Interior Door Upgrades



Optional Transom
*only available for 10' ceiling

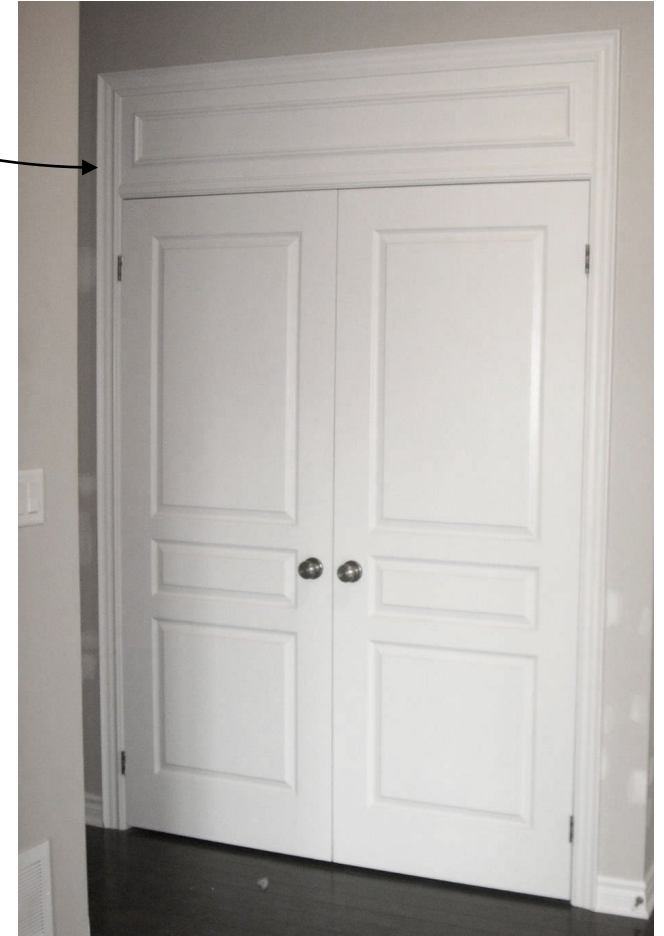

Weiser – Door Hardware Options



MILAN ROUND ROSE
IRON BLACK



MILAN ROUND ROSE
SATIN NICKEL

Weiser – Door Hardware Options



HALIFAX SQUARE ROSE
IRON BLACK



HALIFAX SQUARE ROSE
SATIN NICKEL

Weiser – Door Hardware Options



CAMBIE KNOB
IRON BLACK



CAMBIE KNOB
SATIN NICKEL

Weiser - Exterior Handle Sets



ASHFIELD
Satin Nickel

ASHFIELD
Iron Black

HAWTHORNE
Satin Nickel

Weiser - Exterior Handle Sets



SAN CLEMENTE
Satin Nickel

SAN CLEMENTE
Iron Black

Interior Door Upgrades

Other Interior Door Options:

- Safe & Sound Solid Core Interior Doors (in lieu of hollow core) for increased sound dampening, privacy and durability
- Privacy Door Lock – available in select Interior Door hardware



Closet Door Upgrades



White Board
sliding doors
INCLUDED



White Framed Mirror
sliding doors



Frameless Mirror
sliding doors



Double-swing doors

Closet Interior Upgrades



Double-hanging Wire shelves
UPGRADE



MDF Closet Organizers
UPGRADE

**only available in specific configurations in
select rooms and communities*

Trim, Paint, Wall and Ceiling Options



2/24/2023



Interior Trim Upgrades

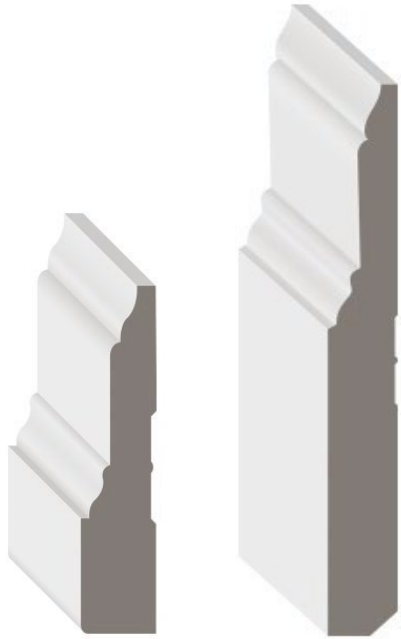

STEP

Casing: 3 1/2"

Baseboard: 5 1/4" or 7 1/4"

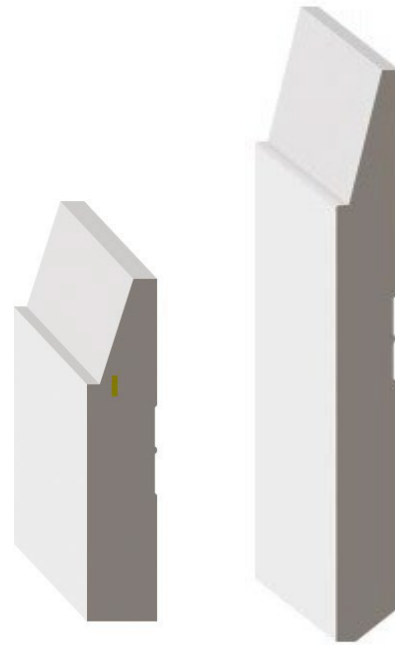

CHAMFERED

Casing: 3 1/2"

Baseboard: 5 1/4" or 7 1/4"

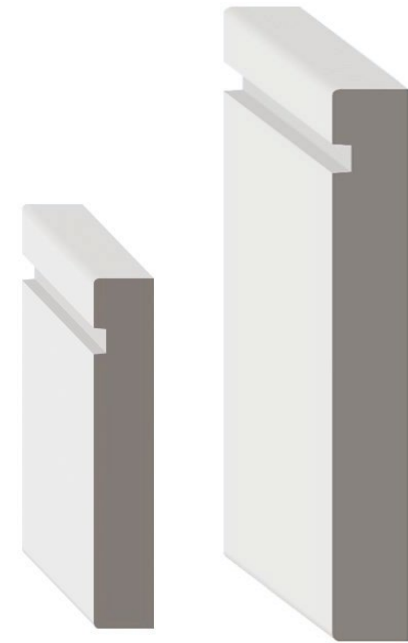

NOTCHED

Casing: 3 1/2"

Baseboard: 5" or 6 1/2"

Interior Paint Options

SW 7632 – MODERN GRAY

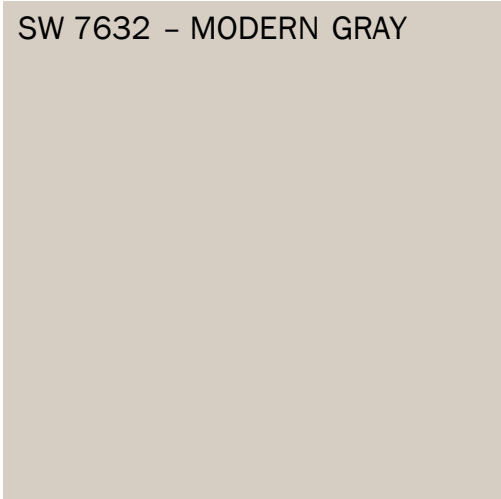

SW 7671 – ON THE ROCKS

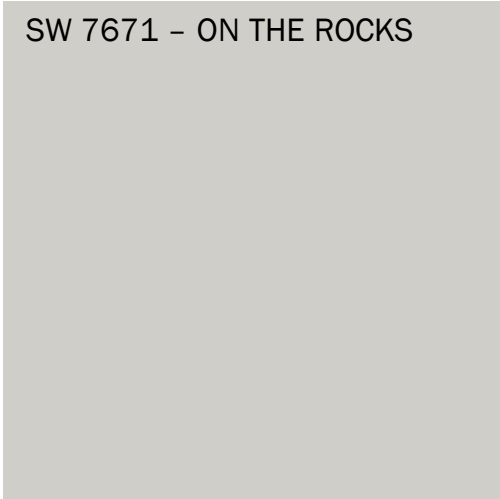

SW 7672 – KNITTING NEEDLES



SW 7043 – WORLDLY GRAY

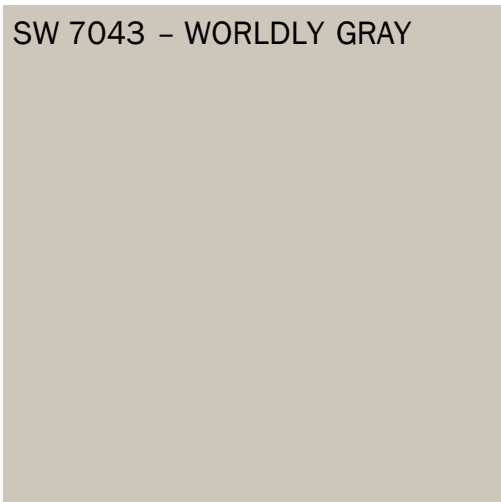

SW 7647 – CRUSHED ICE

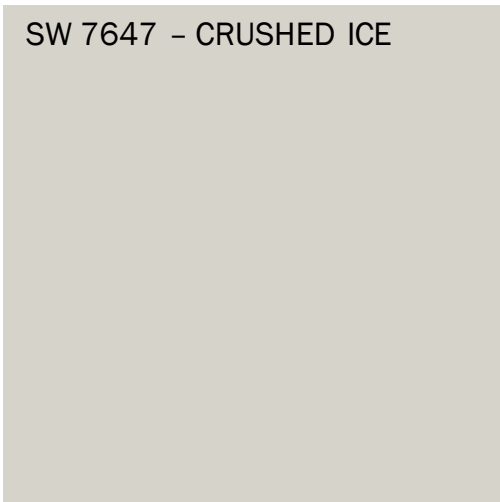

SW7641 COLONNADE GREY

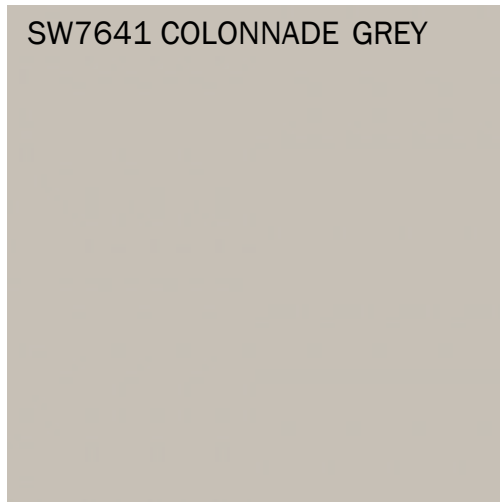

INCLUDED PAINT COLOUR
**SW 7757 – HIGH REFLECTIVE
WHITE**

Wall & Ceiling Upgrades



Shiplap Accent Wall
(horizontal or vertical installation)



Smooth ceilings in lieu of
standard stipple ceiling finish



Sound Insulation:
3-1/2" Fiberglass



Staircase Options

Staircase Options

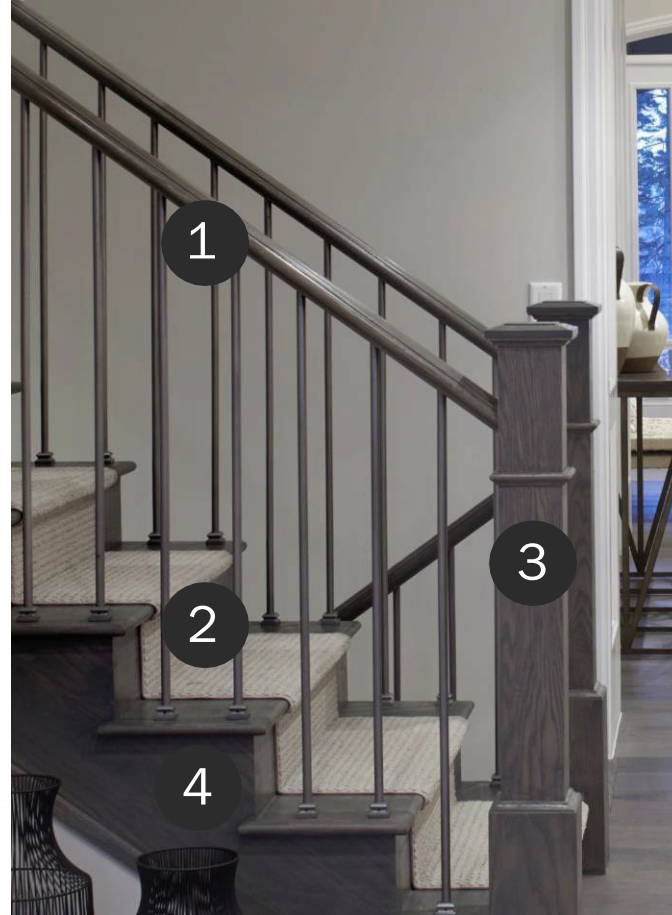

- 1** Handrails - stained finish only
- 2** Pickets - stained, painted or black metal options
- 3** Posts - available stained or painted
- 4** Stringers & Risers
- available stained or painted (split-finish)

Staircase Options: Handrails

only available in stained finish

Handrail Options

Included



Optional



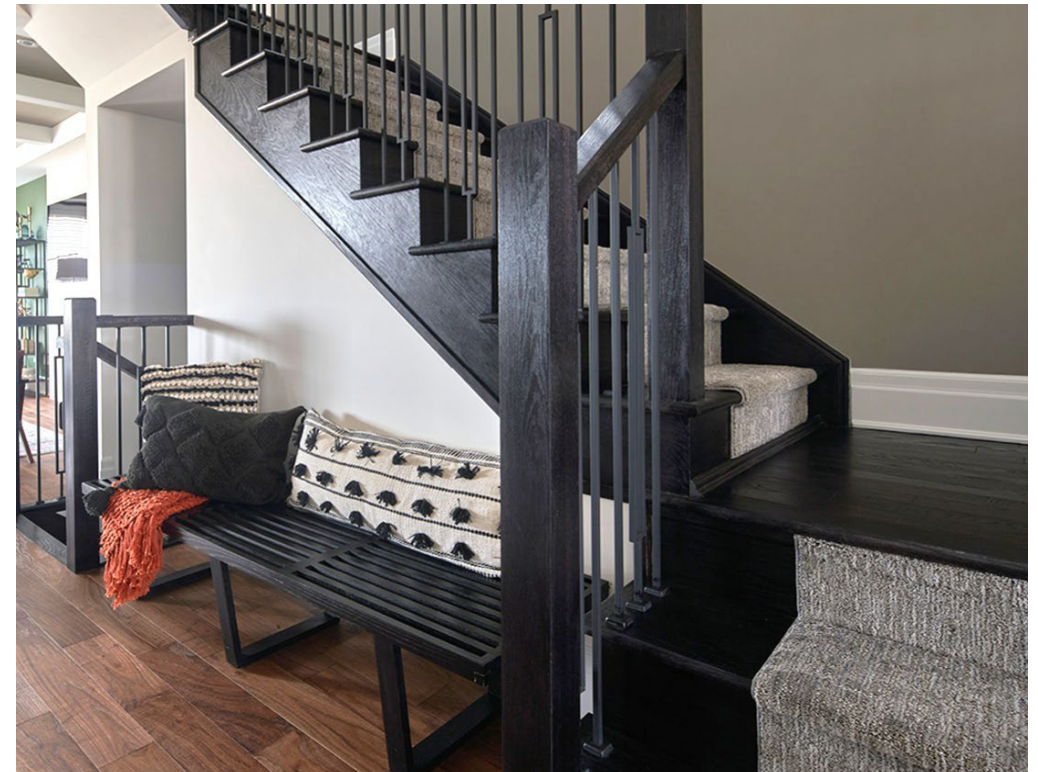
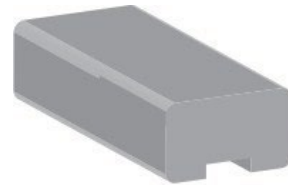

Optional



Optional: R3M handrail
with Single Luxe Metal Pickets and Bala Post

Staircase Options: Wood Pickets

stained or painted finish

	Bala Stained Picket (Included)
	Elora Stained Picket
	V-Groove Painted Picket <i>(painted finish only)</i>







Optional V- Groove Painted Pickets with Paris Post



Optional: Elora Pickets
with R3C handrail and Elora Post

Staircase Options: Metal Pickets

Black metal finish

Image	Name
	Square
	Vogue
	Single Luxe
	Knuckle Series

Metal Picket Pattern

2 Plain – 1 Decorative

3 Pickets per tread, decorative will land in the middle of each tread

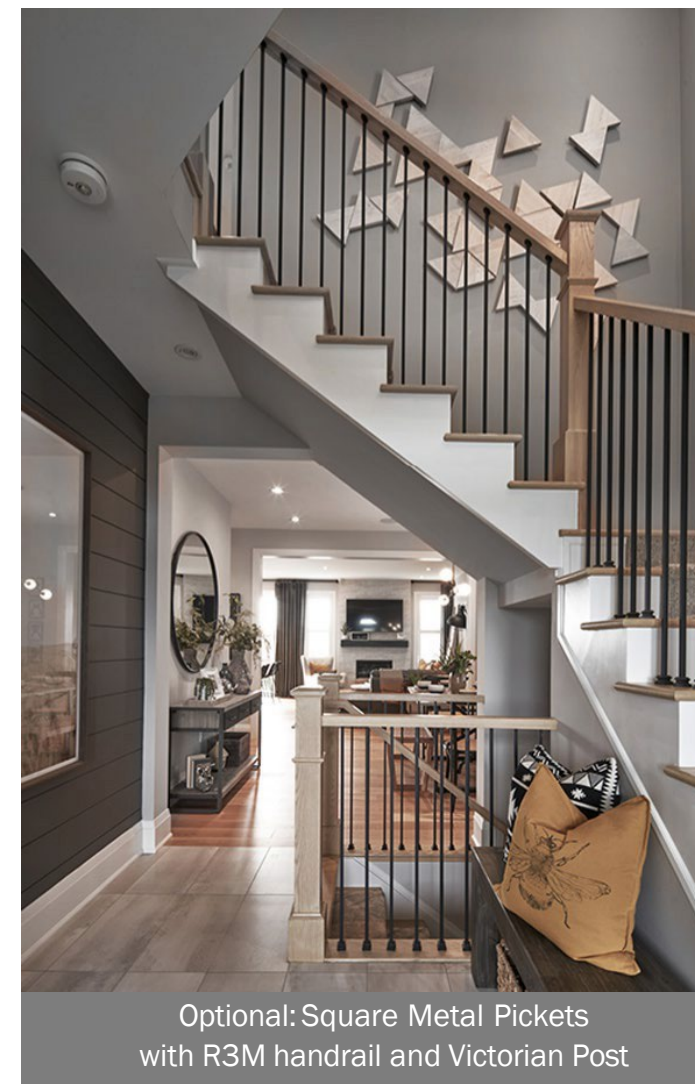

Optional: Square Metal Pickets with R3M handrail and Victorian Post

Staircase Options: Posts

available stained or painted



BALA post
with flat top

INCLUDED



BALA post
with cap

INCLUDED



ELORA
Square Chamfered post



PARIS
4"x4" with 5" base



VICTORIAN
Non-Chamfered
4"x4" with 5" base

**Post cap and profile may slightly vary according to the site and assigned supplier*

Staircase Options: Stringers and Risers

available stained or painted



Stained Stringers & Risers

INCLUDED

“Split-finish”
Painted Stringers & Risers

OPTIONAL

Staircase Stain Options



LAKE ONTARIO



LAKE SIMCOE



LAKE KAWARTHA



LAKE ST. CLAIR



LAKE SUPERIOR

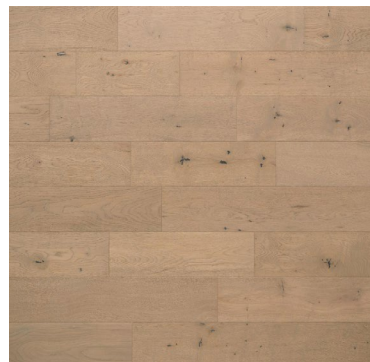

LAKE MUSKOKA

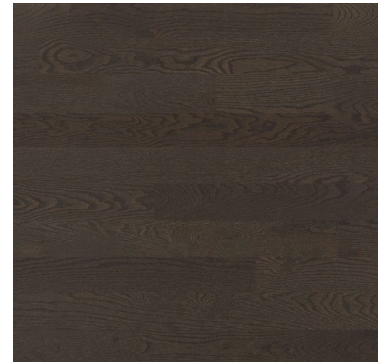

LAKE VERNON

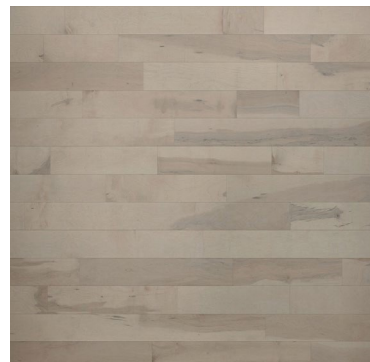

LAKE MICHIGAN

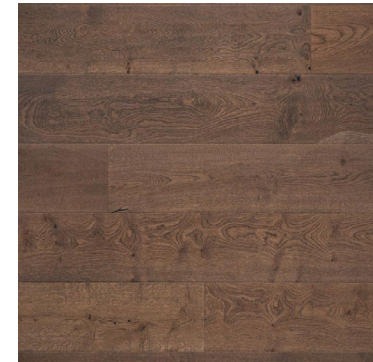

LAKE ROSSEAU

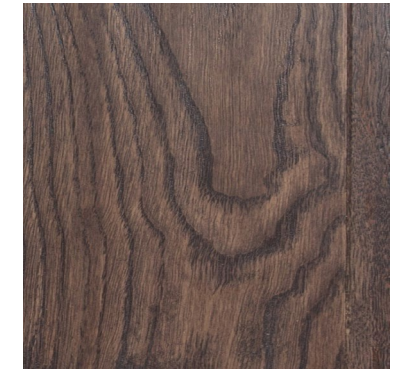

LAKE HURON

Staircase Finish Options

suggested combinations of finishes

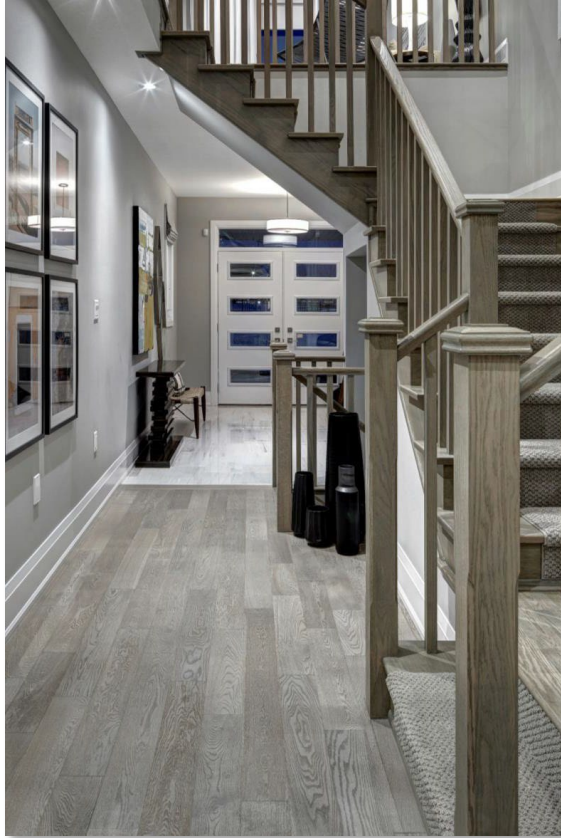

- Complementary Stain
- Stained Risers & Stringers
- Stained Post
- Stained Pickets



- Contrasting Stain
- Stained Risers & Stringers
- Stained Post
- Metal Pickets



- Complementary Stain
- Painted Risers & Stringers
- Stained Post
- Metal Pickets



- Complementary Stain
- Painted Risers & Stringers
- Painted Post
- Painted Pickets



Window & Door Covering Options



Window & Door Covering Options

Roller Shades:

- Nightfall room darkening, Sheerview 1% or Sheerview 3%
- White, Ivory or Grey
- inside-mount cassette or valance

Econo-Vinyl Shutters:

- 2-1/2" or 3-1/2" wide louvers
- with tilt bar and magnetic closure
- available for Patio & Garden doors
- 10-year warranty

Luminaris Vinyl Shutters:

- 2-1/2" or 3-1/2" wide louvers
- outdoor grade vinyl that resists UV discoloration and warping
- color-matched components
- reinforced with aluminum skeleton
- available for Patio & Garden doors
- 25-year warranty
- Made in Canada



Roller Shades



2-1/2" Econo-Vinyl Shutters



3-1/2" Luminaris Vinyl Shutters

Fireplace Options



Fireplace MDF Mantel Options



ER-W MANTEL
INCLUDED



ER-15 MANTEL
Optional



ER-C MANTEL
Optional

- FIREPLACE HEARTH
OPTIONS & ACCESSORIES:
- raised hearth
 - Thermostat control
 - fan kit
 - log sets and liners



Fireplace Beam Options

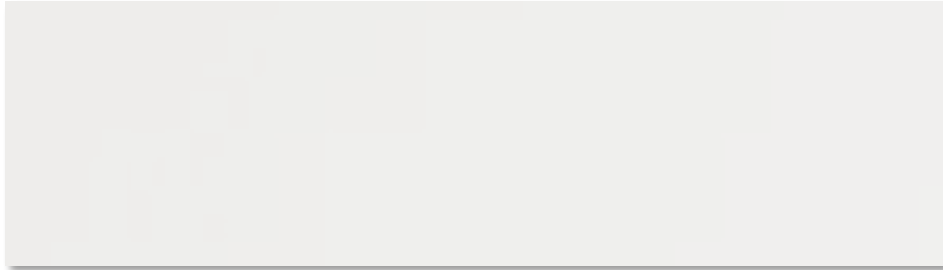

MDF PAINTED WHITE



SILVER GHOST WOOD



BANNAC BROWN GHOST WOOD

5' / 6'
FIREPLACE BEAM
Optional



Fireplace Marble Inlay Options



BIANCO CARRARA

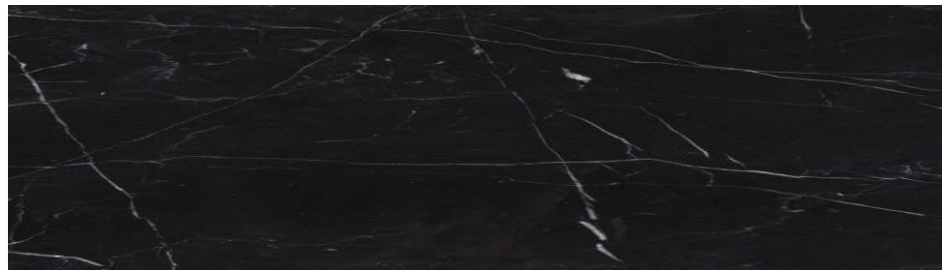

NERO MARQUINA



CREMA MARFIL

MARBLE INLAY
Optional



**three-piece
seams may be visible

Fireplace Dekton Surround Options



REM

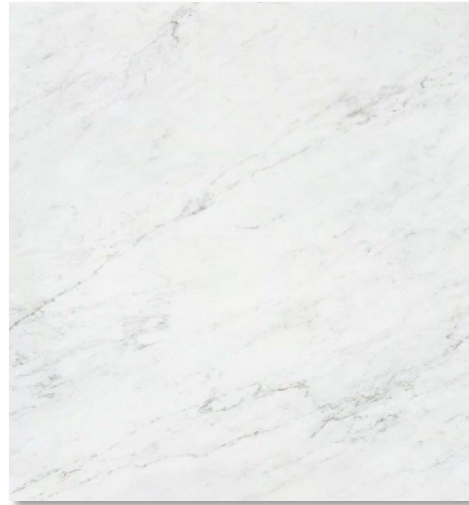

SALINA



KELYA



ALBARIUM



- OPTIONS:
- 4" / 18" bumpout
 - Raised linear fireplace
 - TV ready

Fireplace Tile Surround Options



Group A Fireplace Tile



1. 12 X 24 CALACATTA BORGHINI MATTE
2. 12 x 24 SPLENDID WHITE CLOUD
3. 10 x 30 ROMA STATUARIO FILO
3D DÉCOR MATTE

2/24/2023

Mattamy Homes reserves the right to change the offerings at any time. Photography for representational purposes only. Prices are inclusive of Applicable Taxes and are subject to change without notice. The Vendor attempts to be as accurate as possible when describing its products in the digital catalogue. However, to the extent permitted by applicable law, Vendor does not warrant that the product descriptions, colors, textures, information or other content in the digital catalogue are accurate, complete, reliable, current, or error-free. E & OE.

Group A Fireplace Tile



1. 6 x 36 LAKELAND BLANCO
2. 6 x 36 LAKELAND HAYA

Group A Fireplace Tile

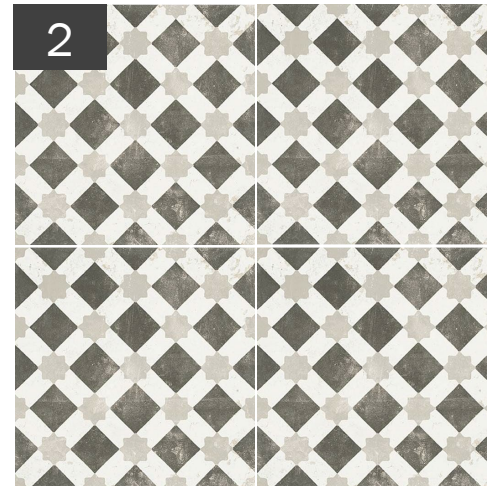

1. 8 x 8 VINTAGE DECORO 4
2. 8 x 8 VINTAGE DECORO 4

Group B Fireplace Tile



1. 12 X 24 FRAY WHITE MATTE
2. 12 X 24 FRAY PEARL MATTE
3. 12 x24 WESTSIDE GREY MATTE

Group B Fireplace Tile

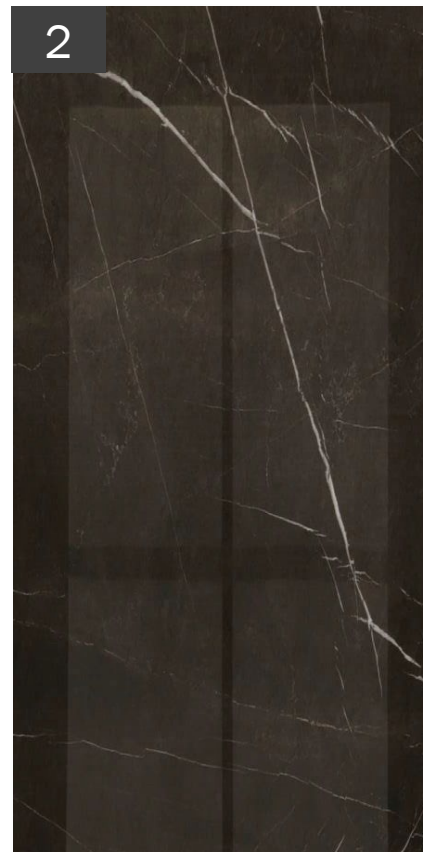

1. 12 X 24 ETERNA VOLKAS WHITE MATTE
2. 12 x24 GATSBY CABARET POLISHED

Group C Fireplace Tile

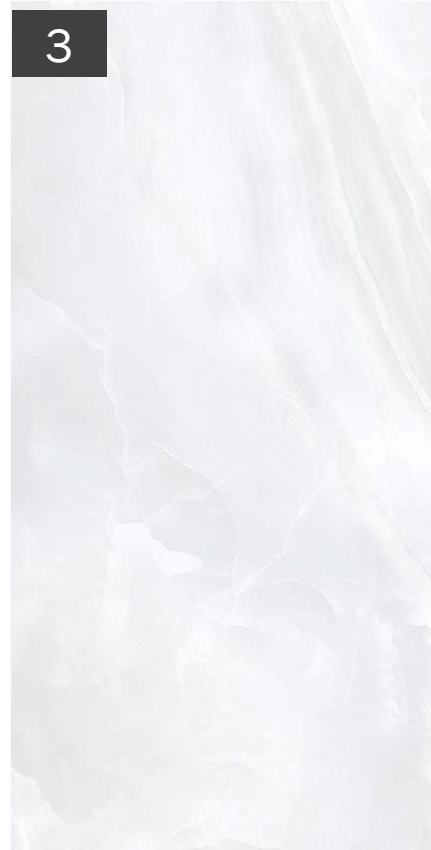
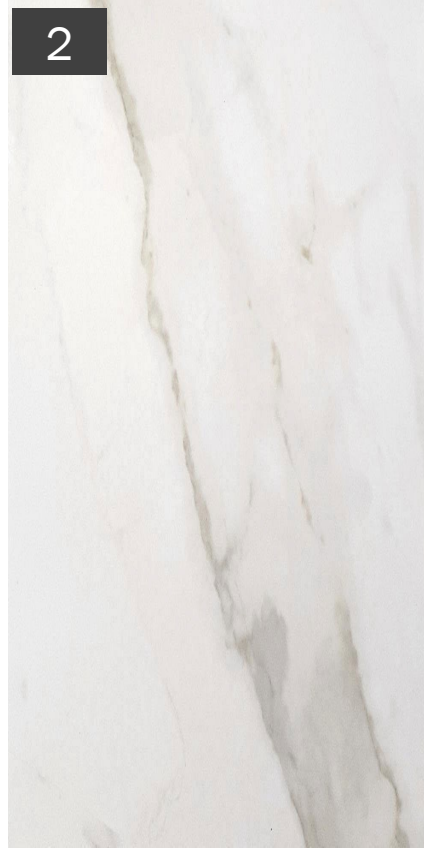

1. 12 X 24 ETERNA VOLKAS WHITE POLISHED
2. 12 X 24 ETERNA CALACATTA TAUPE POLISHED
3. 12 x24 NOLITA BIANCO HONED

Group C Fireplace Tile



1. 12 X 24 ETERNA CALACATTA GREY POLISHED
2. 12 X 24 TIMELESS WHITE POLISHED
3. 12 x24 ETERNA NERO MARQUINA MATTE